



LMX150™

Ground Penetrating Radar

Operation manual

2018-00042-02



Warranty Confirmation

Return this card within 60 days of purchase to confirm your warranty. You can mail it to Sensors & Software, fax it to +1-905-624-9365, or register your product online at www.sensoft.ca/product-registration.

Name:	Company Name:	
Address:		
City:	State/Province:	Zip Code:
Country:	e-mail:	
Phone:	Fax:	

Component Serial Numbers (refer to packing list or the sticker on the component)

Comp:	Serial #	Comp:	Serial #
Comp:	Serial #	Comp:	Serial #
Comp:	Serial #	Comp:	Serial #
Comp:	Serial #	Comp:	Serial #
Comp:	Serial #	Comp:	Serial #
Vendor Name:	Date Received:		

End User License Agreement

Please read the End User License Agreement at <https://www.sensoft.ca/producteula/>

Product Warranty and Limited Liability

Please refer to the terms and conditions included as part of your order acknowledgement and/or invoice for full details of the product warranty and limited liability.

Important Safety Information

Use the Display Unit only as specified in these operating instructions, or the protection provided by the unit may be impaired.

The battery charger/AC adapter must only be connected to a power outlet which provides a protective earth (ground).

Connect the AC power cord only to designated power sources as marked on the battery charger/AC adapter.

The battery charger/AC adapter is rated for indoors use only.

Do not replace detachable MAINS supply cords for the battery charger/AC adapter by inadequately RATED cords.

Do not position the Display Unit such that it is difficult to disconnect the 37-pin GPR connector.

The exterior of this product should be cleaned using a damp cloth.

Safety Symbols



Consult this documentation in all cases where this safety symbol appears. This symbol is used to inform you of any potential HAZARD or actions that require your attention.

Do not attempt to open or dismantle any part of this equipment unless directed specifically by this manual. Doing so may render the equipment faulty and may void the manufacturer's warranty.

Use authorized accessories only. Incompatible accessories may damage the equipment or give inaccurate readings.

Follow your company and national safety procedures and or requirements when operating this equipment in any environment or workplace. If you are unsure what policies or procedures apply, contact your company or site's occupational health and safety officer or your local government for more information.

Table of Contents

1. Overview	11
2. Assembly	13
2.1 Out of the box	13
2.2 External GPS (optional)	17
2.3 Fully Assembled	19
3. Getting Started	21
3.1 Powering Up	21
3.2 Shutting Down	22
3.3 Interacting with the Display Unit	22
3.4 Swipe Down Menu	23
4. Tools & Setup	25
4.1 Preferences	25
4.1.1 Language / Locale	26
4.1.2 Units	26
4.1.3 Date/Time	26
4.1.4 Volume	26
4.1.5 Brightness	27
4.1.6 Wi-Fi Network	27
4.1.7 Email	28
4.1.8 Screen Saver	33
4.1.9 GPR Plot Options	33
4.1.10 Reset to Defaults	34
4.2 System Test	35
4.2.1 System Information	35
4.2.2 Keypad	36
4.2.3 Audio	37
4.2.4 Touch Screen	38
4.2.5 GPR Sensor	38
4.2.6 Odometer	39
4.2.7 GPS	41
4.3 File Management	44
4.3.1 Screenshot Gallery	45
4.3.2 Delete Project	46
4.3.3 Map View	46
4.3.4 Export Data	46
5 GPR Concepts	47
5.1 Theory	47
5.2 Hyperbolas	47
5.3 Calculating Depth	48
5.4 Soil Calibration values	48
5.5 Air Waves	49
6 Line Scan	51
6.1 Selecting a line	51
6.2 Acquiring Data	53
6.3 DynaQ®	54
6.4 Back-up Indicator	54
6.5 Flags	56
6.6 Line Scan menu options	57

6.6.1	Zoom	57
6.6.2	Color	59
6.6.3	Filter	59
6.6.4	Gain	60
6.6.5	Soil Cal	61
6.6.6	Interp	63
6.6.7	No Save Mode	65
7	Grid Scan	67
7.1	Grid Parameters	67
7.1.1	Grid Number	67
7.1.2	Grid Size	69
7.1.3	Grid Resolution	69
7.1.4	Starting data collection	70
7.2	Laying out the grid	70
7.3	Data Collection	72
7.3.1	Physical Data collection	72
7.3.2	Data collection on the Display Unit	73
7.3.3	Collecting around an obstruction	74
7.3.4	Line View	74
7.3.5	Recollecting & skipping lines	75
7.3.6	Processing data	76
8	Slice View	77
8.1	Depth	77
8.2	Line View	78
8.3	Color	78
8.4	Grid Lines	80
8.5	Recollecting lines	81
9	Map View	83
9.1	Accessing Map View	83
9.2	Map View screen	83
10	Demonstration Data	85
11	Capturing Screens & E-mailing Mini-Reports	89
11.1	Capturing Screens	89
11.2	Using the Hotspot on your Smartphone	90
11.3	Mini-Reports	91
12	Transferring Data to a PC	93
12.1	Formatting USB Sticks	94
12.2	Directory Structure	95
12.3	Field Interpretations File	96
12.4	Google Earth™	96
12.5	System Summary Report	98
12.6	EKKO_Project™	98
13	Troubleshooting	101
13.1	System Does Not Power Up or Sensor Not Detected	101
13.2	System Communications	105
13.3	System Overheating	106
13.4	Display Unit Problem	106
13.5	Wobbly Wheels	106
13.6	Creating a Test Line for Data Quality	106
13.7	Contacting the Vendor for Service	107

14	Care & Maintenance	109
14.1	Battery Care	109
14.2	Cable Care	110
14.3	Skid Pads	110
14.4	Odometer	110
14.5	Storage Cases	110
14.6	Upgrading Embedded Software on Display Unit	110
15	Parts List & Accessories	113
15.1	Spare Parts	113
15.2	Accessories	115
16	Technical Specifications	117
	Appendix A: Health & Safety Certification	119
	Appendix B: GPR Emissions, Interference and Regulations	121
	Appendix C: Instrument Interference	129
	Appendix D: Safety around Explosive Devices	131
	Appendix E: Wi-Fi Module	133
	Appendix F: Calibration	135

1. Overview

The manual references embedded software version V1 R1. To see which software version is installed on your system, see the Swipe Down menu in [Section 3.4](#).

The LMX150™ FINDAR® is a complete Ground Penetrating Radar system, offering two modes for acquiring data: Line Scan and Grid Scan. Once the unit is assembled and powered-up, you can start conducting a GPR survey in less than a minute.

Features of LMX150™ FINDAR® include:

- High visibility, touch screen display
- Display depth slices from collected grids, right in the field
- UWB (ultra-wide band) Antenna producing highest data quality
- Lightweight fibreglass cart frame
- Built-in Wi-Fi capability
- Integrated GPS receiver with optional external GPS for increased positional accuracy for geo-referencing data
- Ability to mark surface flags and subsurface interpretations directly in the data
- Display your travelled path and targets in Map View
- Seamless export of data to EKKO_Project™ software for further data analysis

This manual describes the operation of the LMX150™ FINDAR® system and collecting GPR data. There is also a section that describes the basics of GPR theory and techniques for proper surveying.

2. Assembly

2.1 Out of the box

You will find the following components in your box. Some of these may already be assembled.

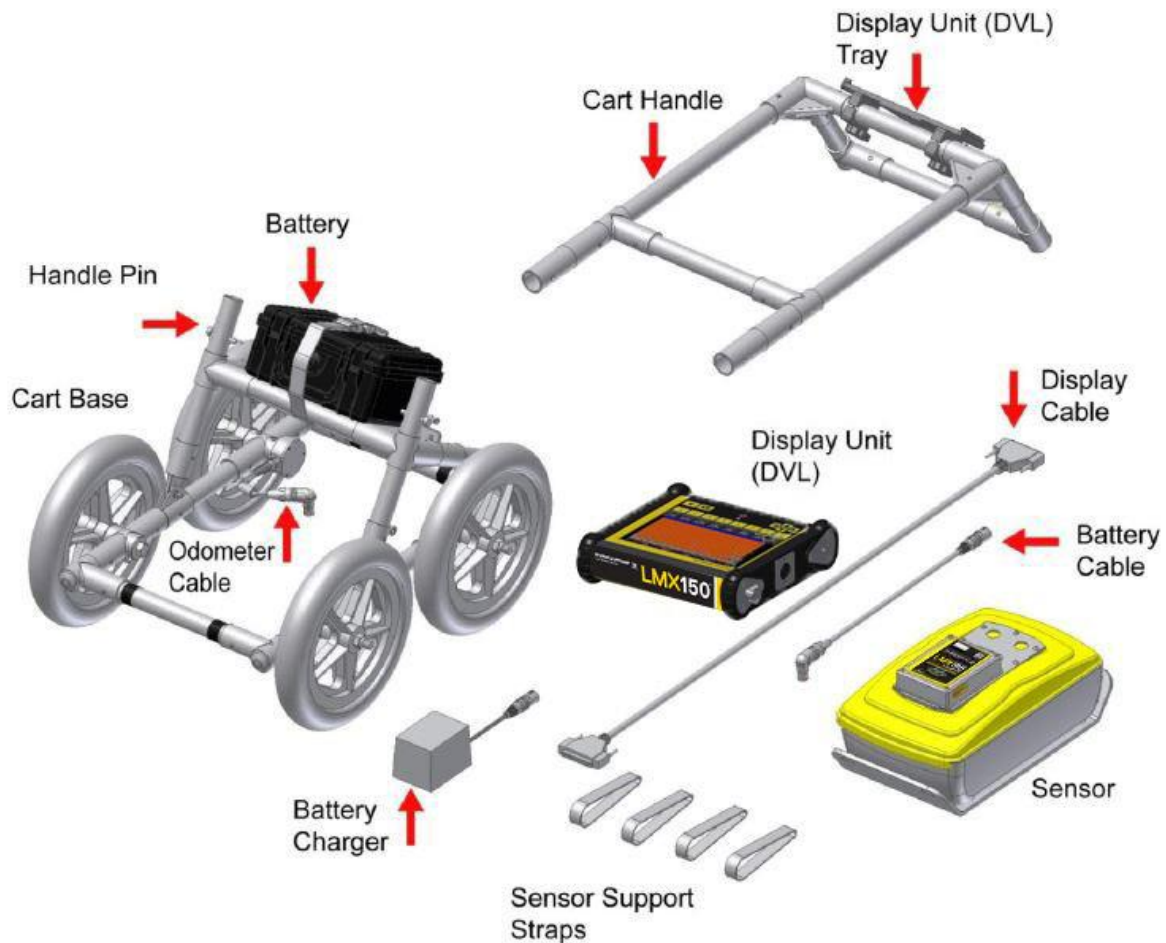

Attach the Cart Handle to Cart Base using the Handle Pins. Ensure the Display Unit Tray is facing the operator.



Attach the GPR Sensor to the Cart using the Sensor Support Straps. Ensure the Sensor is oriented the correct way with the connections toward the back of the Cart. Using the Sensor Support Straps, adjust the height of the Sensor so it is 1-2 cm ($\frac{1}{2}$ – $\frac{3}{4}$ inch) above the ground. The best way to get a uniform Sensor height is to place a couple of sheets of thick cardboard, particle board or Styrofoam under the sensor before securing the Sensor Support Straps.

Note that the straps come in two different lengths. The 2 shorter straps attach at the front, and the 2 longer straps attach at the rear.

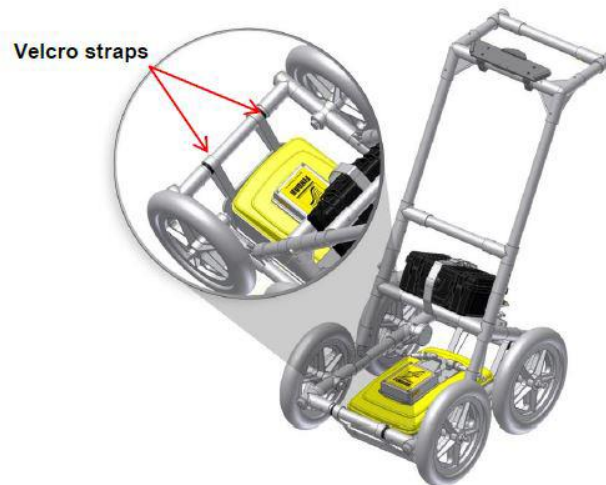

Attach the Display Unit onto the Display Unit Tray on the Cart. The Display unit slides down into the tray, catching on both sides of the mount and is held in place with the pull pin. When a click is heard, the Display Unit is firmly in place. Adjust the angle of the Display Unit by loosening the hand-screws underneath the Display Unit Tray, rotating the Display Unit to the desired angle and tightening the hand-screws. To remove the Display Unit, pull out the pull pin and lift the Display Unit up.



Attach the Display Cable to the back of the Display Unit with the jackscrews.



Connect the other end of the cable to the Sensor. Ensure the cable is routed as shown below.



Set the battery onto the inclined shelf on the back of the cart. Align the Velcro on the battery to the Velcro on the cart. Secure battery by fastening the plastic buckle and tighten straps if necessary. Attach the Odometer and Battery Cables. The Odometer Cable connects from the odometer to the closest receptacle on the Sensor. Attach the Battery Cable to the Sensor and the other end to battery.

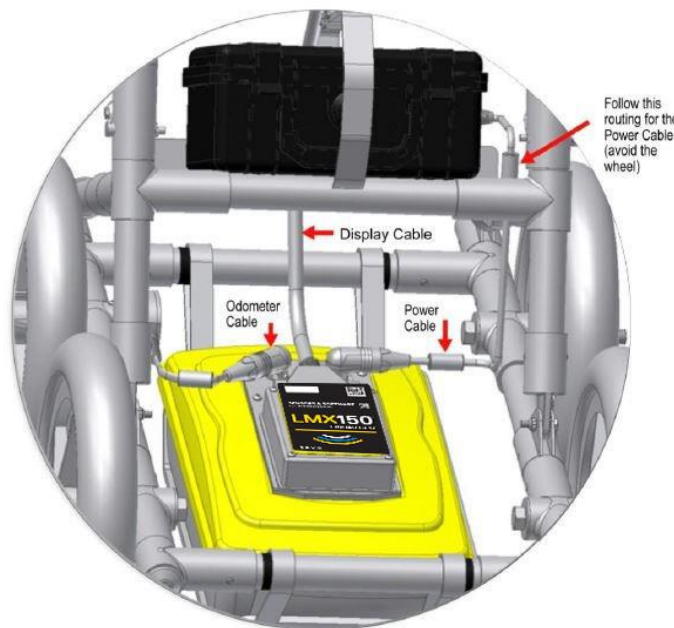

2.2 External GPS (optional)

The instructions for connecting the GPS, mount and cable are below:

GPS Mount – The GPS mount attaches to the crossbar frame above the battery, using a quick release pin. There is a pipe plug that needs to be removed first.



Once that is done, ensure the pole is pointed up, then insert the GPS mount into the opening where the plug was removed and secure with the quick release pin. This allows the GPS to sit directly over the middle of the GPR sensor. It comes with 5/8-11 UNC-1A threads at the top of the pole, which is standard for many GPS receivers.

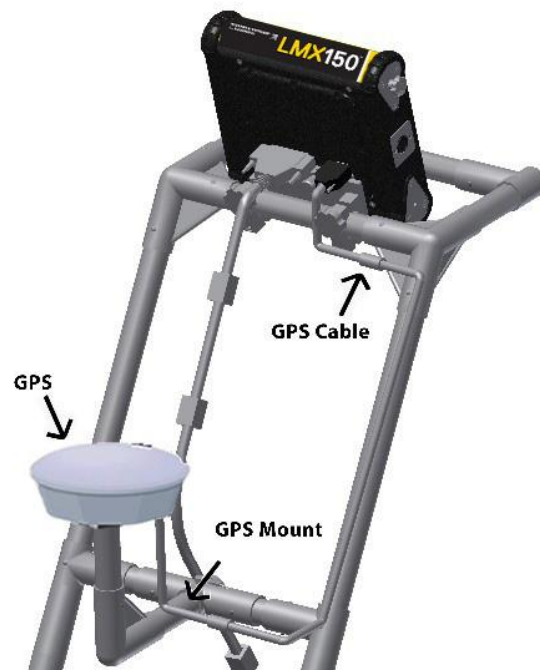

GPS – If you have purchased the Trimble AG-200 GPS from Sensors & Software, this can be screwed onto the threads at the top of the GPS mount. Ensure that you use the cable labeled AG-200 that comes with the Trimble GPS; do not use any other cable, as the internal wiring is

different and could damage the Trimble AG-200 GPS. Connect the 90° end of the GPS cable to the GPS receiver, and the other end to the serial port on the back of the display unit. This single cable powers the GPS and receives data from it. Ensure that the Display Unit is powered down when connecting or disconnecting the GPS cable.



If you choose to connect a 3rd party GPS receiver, you must ensure the following parameters are set for the GPS to communicate with the Display Unit:

- Baud rate = 19200 bps
- Output string = NMEA
- NEMA string must include `###GGA`
- Parity = None
- Stop Bits = 1
- Data Bits = 8

NOTE: Since the serial port of the Display Unit outputs power (current=1A, voltage=12V), be very careful if connecting other GPS units to the serial port. Verify the pins on the drawing below.

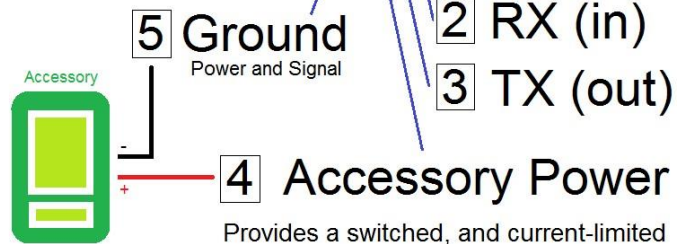
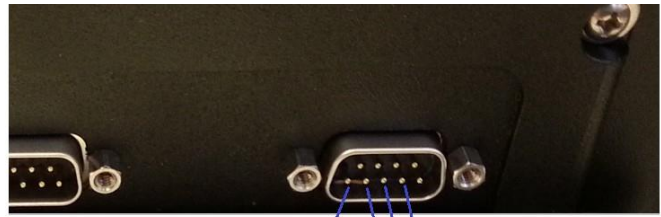

Provides a switched, and current-limited positive(+) feed from the system battery.



Care should be taken to ensure that the accessory can handle the supplied power, and that it does not feed power back into the GPR system.

2.3 Fully Assembled

The fully assembled LMX150™ FINDAR® will look like the following. Simply reverse directions to disassemble for transport.



3. Getting Started

3.1 Powering Up

When the battery is first plugged in, the LED goes green for 5 seconds then disappears.

To start the system, press the red power button on the display unit. The LED on the front panel will light up red.

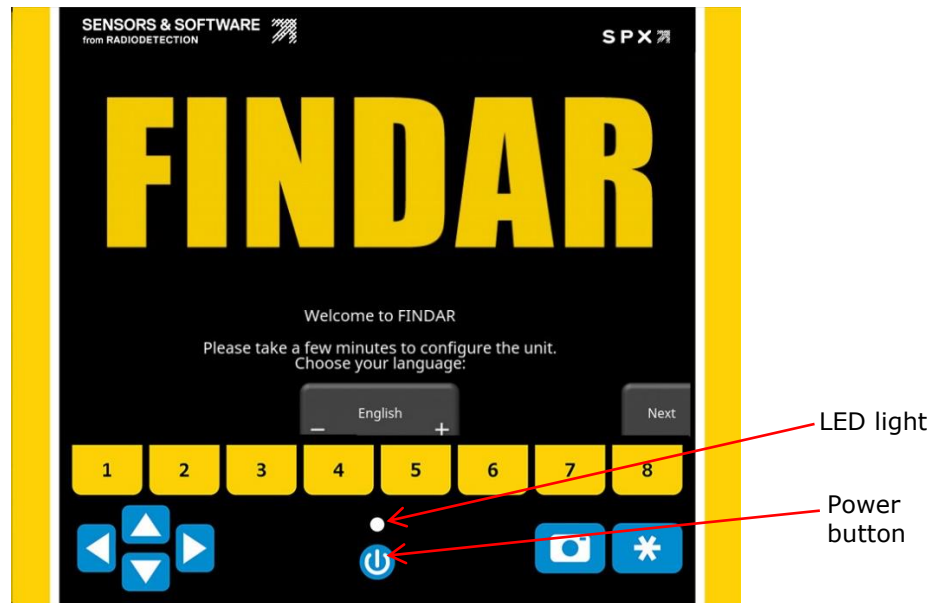

Figure 3-1: Display Unit

Once boot up is complete, the colour of the LED will indicate the amount of battery power remaining:

- 100% to 20% = green
- 20% to 10% = orange
- 10% to 0% = red

The first time you turn on LMX150™ FINDAR®, you will need to configure the system (Figure 3-1). A series of screen prompts will allow you to setup the language, units, date & time, and some other options. You will have to do this again anytime you update the embedded software ([Section 14.6](#)).

Every subsequent time the system boots up, you will see the main screen (Figure 3-2).

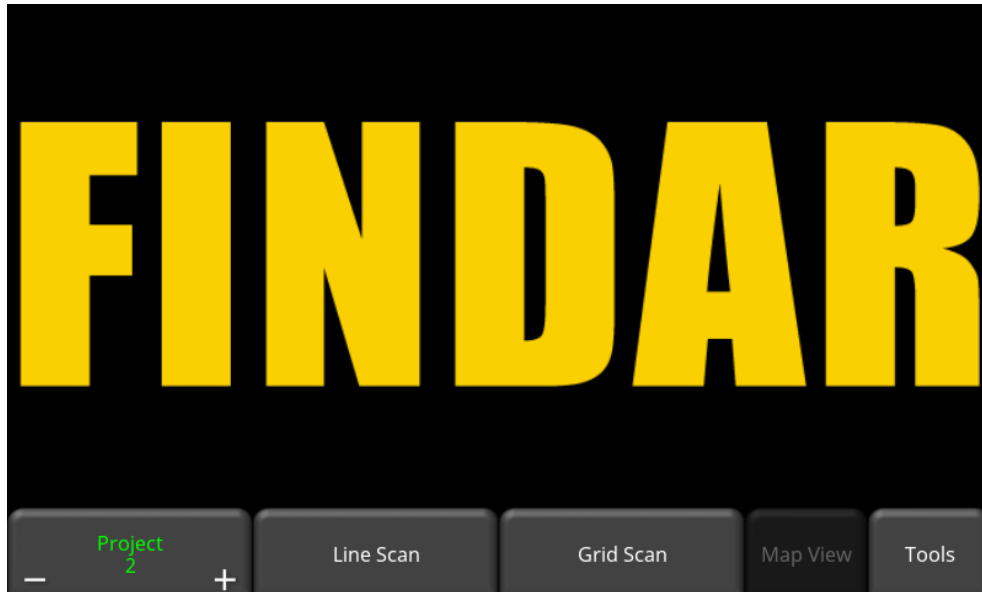

Figure 3-2: Main Screen for LMX150™ FINDAR®

From the main menu, select the project number to work in. Projects that contain data are in red color, whereas those with no data are in green. As you change projects, the main screen will also display the number of lines and grids collected in each project. These will appear under the Line Scan and Grid Scan buttons respectively.

3.2 Shutting Down

To power down, press the red power button on the display unit once. A confirmation message will appear, after which you can press **Yes** to proceed. If necessary, a hard shutdown can be done by pressing and holding the red power button until the unit shuts down.



3.3 Interacting with the Display Unit

Data collection is controlled by the Display Unit. The Display Unit has embedded software to set survey parameters and collect, display and store data.

The Display Unit offers touch screen operation, as well as a water-resistant membrane keypad with a number of buttons that can be pressed to perform various tasks. Most operations can be done using either the touch screen or the keypad.

Use the following table as a guide to working with the keypad on the Display Unit:

Item	Description
Menu Buttons 	The yellow buttons labelled 1 to 8 correspond to menu choices that appear on the screen.
4-way directional keypad	Controls Up/Down/Left/Right operations in certain menus.

Item	Description
	
Camera 	Saves a screenshot of line data, grid data or the Map View display.
Asterisk / Special Function 	Used for adding Flags during data acquisition, and to quickly enter the No Save mode for Line Scan data collection.

3.4 Swipe Down Menu

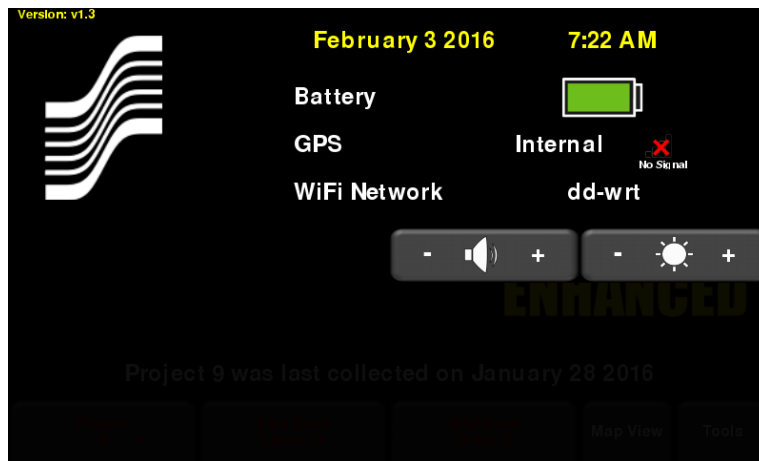

Figure 3-3: Swipe-Down menu

When the Display Unit is powered on, you can “swipe” your finger from the top of the screen towards the bottom, to display a Swipe-Down menu (Figure 3-3) with the following items:

Date and Time: The current date and time (12-hour clock). The time needs to be changed in areas that observe daylight-savings-time.

Battery: The battery icon displays the amount of power remaining in the battery.

GPS: Shows which GPS is being used (Internal or External) and the signal strength.

Wi-Fi Network: Indicates if the system is connected to a wireless network and, if so, the name of the network. See [Section 4.1.6](#) for details on connecting the system to a wireless network.

Volume: The Volume + and - buttons are used to increase and decrease speaker volume.

Brightness: The Brightness + and - buttons are used to increase and decrease the screen brightness. For example, increasing the Brightness setting may improve the visibility of the screen in bright sunlight. Note, however, that increasing the screen brightness also increases power consumption, thus reducing battery life.

To close the Swipe-Down menu, touch anywhere on the screen below the swipe-down menu.

4. Tools & Setup

From the main screen shown in Figure 3-2, press **Tools** to enter this sub-menu. Here you can set preferences, adjust system settings, perform system tests and manage files. You will see the screen shown in Figure 4-1:



Figure 4-1: Tools Menu

4.1 Preferences

Selecting the preferences option will take you to the sub-menu shown in Figure 4-2.

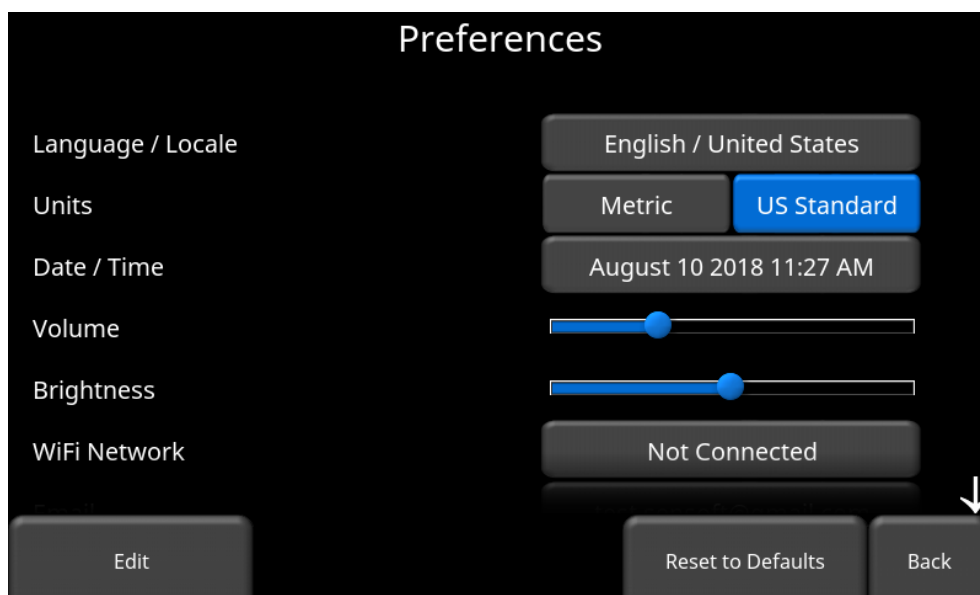

Figure 4-2: Setting Preferences

There are several parameters that can be modified. Touch the screen and swipe up or down to scroll and view additional parameters. To change a value, press the value on the right side of the screen. Alternatively, use the up and down arrows on the 4-way keypad to highlight the desired parameter, then press Edit. Each parameter is described in detail below.

4.1.1 Language / Locale

Selecting this option will display the screen in Figure 4-3. The current language is displayed; pressing the + and – buttons on either side of the language will cycle between the languages currently available. Below that, the Country/Region is displayed. Press the + and – buttons on either side of the displayed Country/Region to alphabetically move to the next or previous country or region.

Alternatively, both Language and Country/Region can be changed by pressing the + and – buttons on the bottom of the screen. Press **Back** when you are done.



Figure 4-3: Changing Language and Country/Region

4.1.2 Units

Pressing **Units** will cycle between US Standard and Metric Units.

4.1.3 Date/Time

Selecting this option takes you to a screen where the date and time can be set. The time is manually set and will not automatically correct for daylight savings time.

4.1.4 Volume

Scroll bar for adjusting the volume of clicks and beeps heard during operation. This can also be changed by using the Swipe Down menu ([Section 3.4](#)) anytime the system is not collecting data.

4.1.5 Brightness

Scroll bar for adjusting the brightness of the screen. Note that increasing the brightness consumes more battery power. This can also be changed by using the Swipe Down menu ([Section 3.4](#)) anytime the system is not collecting data.

4.1.6 Wi-Fi Network

Connecting to a wireless network allows you to send a mini-report to someone by e-mail. This connection can be through a standard Wi-Fi network or through a hotspot on your mobile device while in the field.

Note that the system CANNOT connect to Public Hotspots (typically restaurants, hotels and airports) that require a web-based login and acceptance of their Terms & Conditions. It also CANNOT connect to unsecured networks (networks that do not require a password).

If you are already connected to a Wi-Fi network, the name of the network is listed beside the Wi-Fi Network field. Selecting **Wi-Fi Settings** takes you to a sub-menu (Figure 4-4) for connecting and configuring Wi-Fi settings.

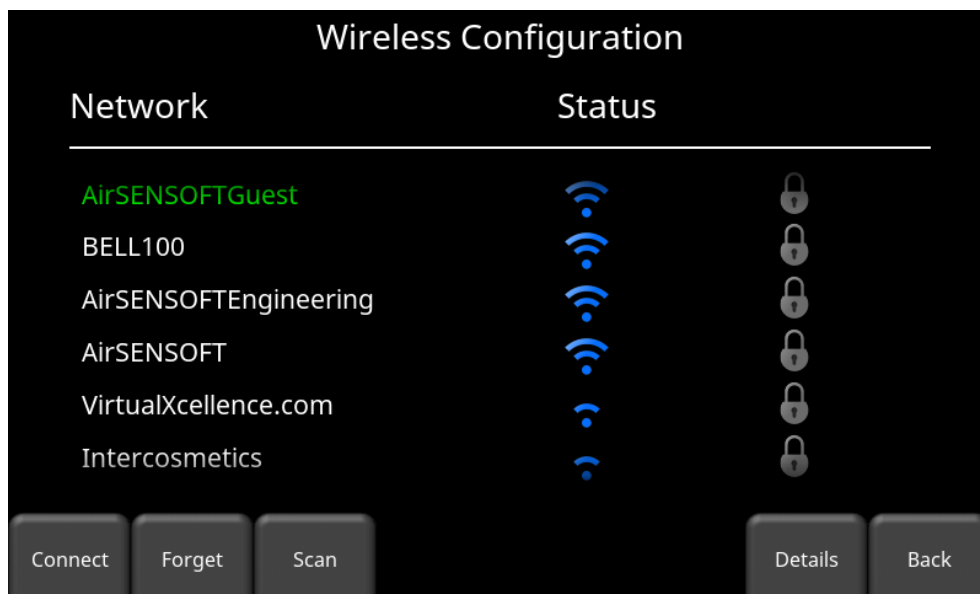

Figure 4-4: Configuring Wireless settings and E-mail address

Use the 4-way directional arrows or touchscreen to select the network. The color of the Network Name indicates the status:

- Green = Connected
- Yellow = Not currently connected, but remembered from before when you previously connected and entered a password.
- White = Not connected

- **Connect** – Select the desired network and press Connect. If the connection is successful (this can take a minute or so) a screen appears asking for the password for that network. If the network name is yellow (from a previous connection to this network), it will not ask for a password because it is a remembered network. Once it connects the Network Name will turn green.
- **Forget** – Use the Forget button to remove the password for connected or remembered networks (text in green or yellow). Once the ‘forget’ button is pressed on a selected network it will remove the password and the Network Name will turn white. You will also be disconnected if you are currently connected to that network.
- **Scan** – Scans for any available networks in the area and displays them in order of strength of signal. You may need to press this button a second time if you don’t see the network you are looking for.
- **Details** – Pressing this button displays the security settings and device addresses related to the selected network.
- **Back** – Press this button to return to the System Settings screen.

4.1.7 Email

Press **E-mail** to arrive at a sub-menu where you can setup and configure a sending e-mail address. Ensure that this e-mail address already exists. This is the sending account where messages will originate from. All mini-reports received by the recipient will appear to come from this account.

Using Gmail

Using a Gmail address on the DVL-500 requires “app specific password”. An app specific password is a 16 character randomly generated passcode that allows access to a portion of the overall Google account. These passwords can be deleted at any time if the user feels it has been compromised. Note that 2 factor authentication is required for the use of app specific passwords.

The following procedure details the steps required to enable and generate an app specific password:

- 1) Log into Google account on a desktop computer.
- 2) Click on the top right account icon and select **Manage your Google Account**

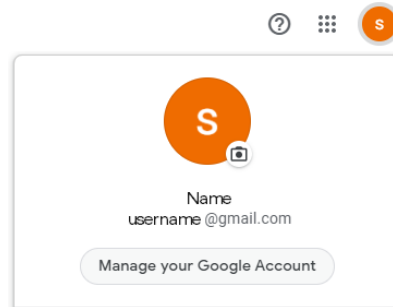

3) Select **Security** from the left menu

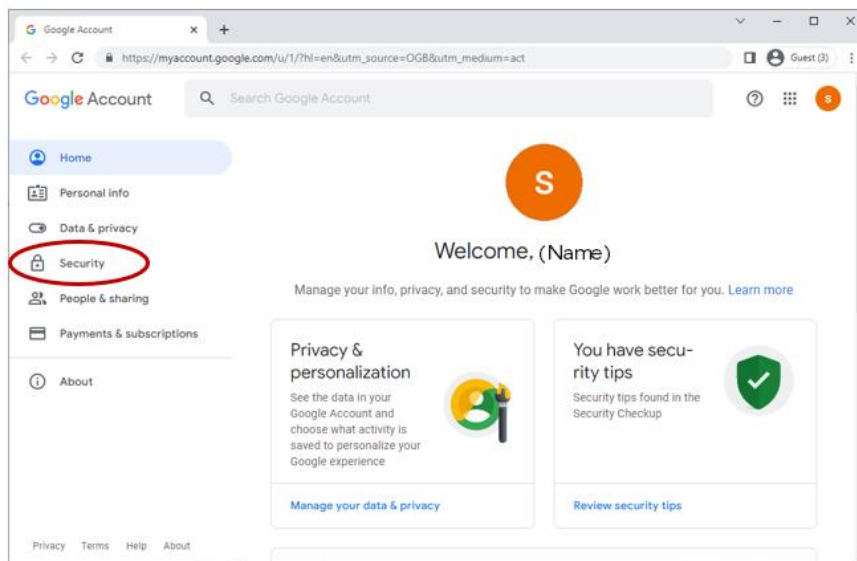

4) Scroll down to the **Signing into Google** section and turn on **2-Step Verification** (if it is not already enabled). Follow the onscreen instructions to add/verify your phone number

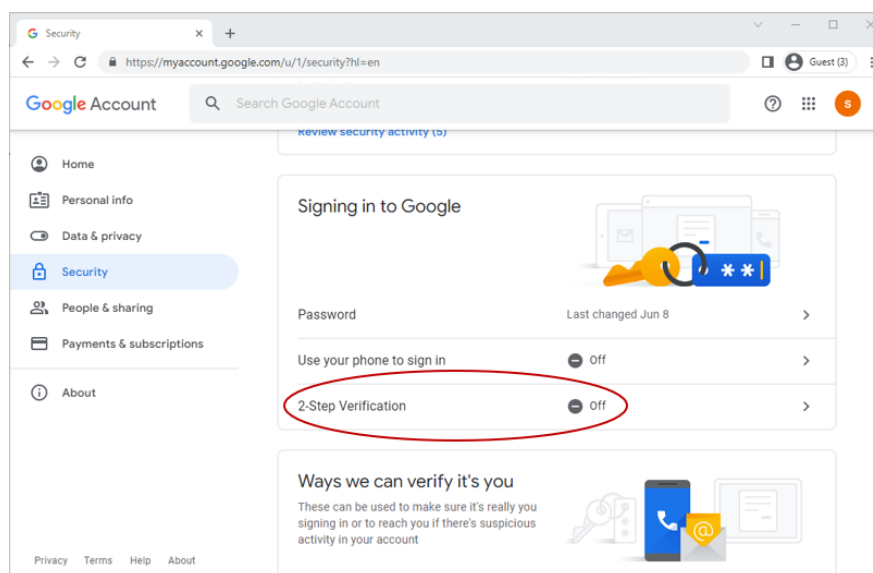

5) Return to the Security menu and you should now find the **App passwords** option under **Signing into Google**. Click on **App passwords**.

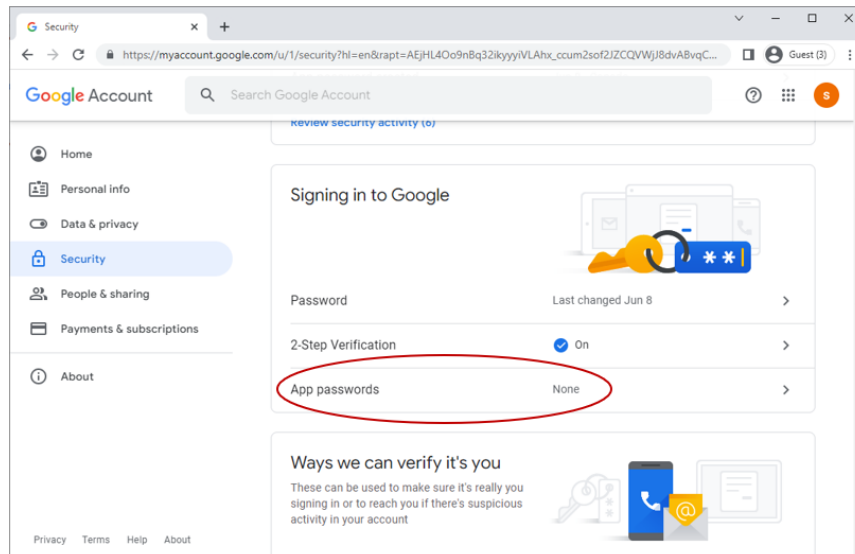

6) Under “Select app” choose **Mail**, and under “Select device” choose **Other** and enter an appropriate name (i.e., DVL). Click **Generate**.

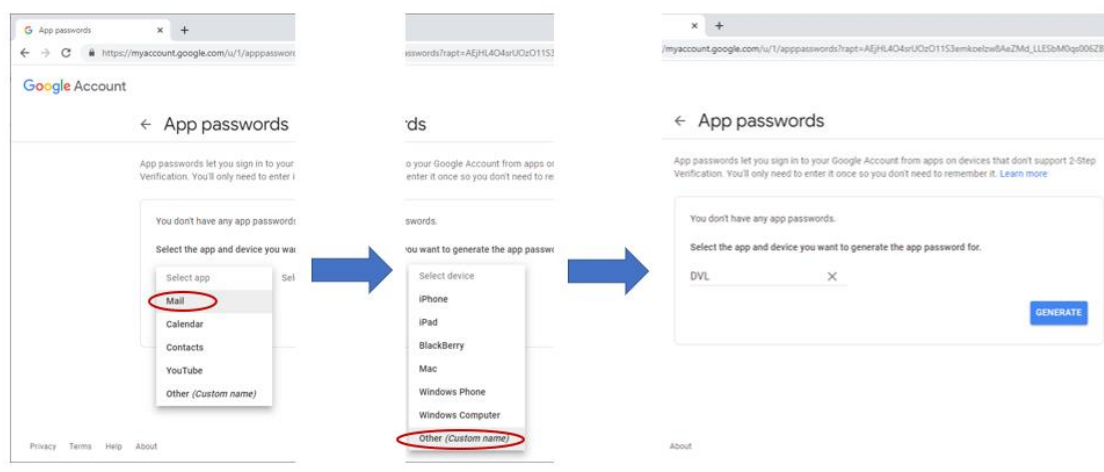

7) Use the generated 16-character password when configuring your Gmail account on the DVL:

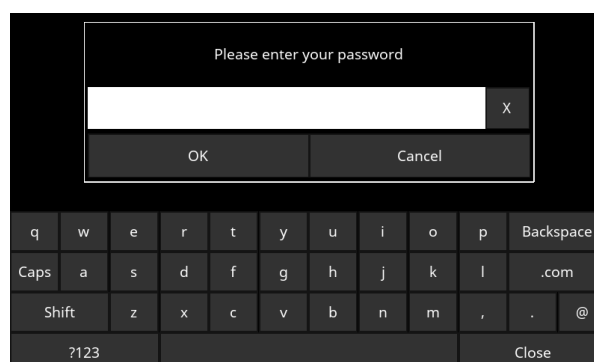

Once you have made the changes in your Google account, continue below (Figure 4-5):

Outgoing Email Setup

Provider	Gmail
Username	test.sensoft
Password	*****

Provider
Gmail

Username

Password

Save

Cancel

Figure 4-5: Using GMAIL as e-mail provider

- Press **Username** to display a keyboard where you can enter your GMAIL username only; you do **not** need to enter @gmail.com. Then press OK when done (Figure 4-6a)
- Press **Password** to display a keyboard where you can enter the app-specific password from the link above. Then press OK when done (Figure 4-6b)
- Press **Save** when both Username and Password have been entered.

Figure 4-6: Entering e-mail address (a) and password (b) for GMAIL

If there are no warning messages, the e-mail address is setup properly and you are ready to e-mail mini-reports from the field. If this does not work, see the [Failed Setup](#) section below

Using Another Provider

To use another e-mail provider, press the **+** and **-** buttons under **Provider** until it says **Custom**. This will display the screen shown in Figure 4-7 allowing you to setup and configure a different e-mail provider:

Figure 4-7: Entering e-mail address and password for another e-mail provider

- Press **Username** to display a keyboard where you can enter the complete e-mail address, then press OK when done.
- Press **Password** to display a keyboard where you can enter the password, then press OK when done.
- Press **Host Name** to display a keyboard where you can enter the name of the server address handling the outgoing mail. See chart below for some common e-mail providers. If your provider is not listed, it can usually be found by searching online for “SMTP host name <provider>”, where provider is the host name e.g. Yahoo or AOL. Press OK when done.
- Press **Server Port** to display a keyboard where you can enter the port number used by the email server. Searching online for host name will usually provide the port number for that e-mail provider. In most cases, it’s usually 465 (if SSL is enabled, see next bullet point), or 587. See chart below for some examples. Press OK when done.
- Enable SSL – you can select **On** or **Off** on the display. SSL provides encryption security. Some e-mail providers require this set to ON. This will usually be indicated on the same online search page that was used above. See the chart below for examples.
- Press **Save** when all the information is entered and correct.

Below is the chart for some common e-mail providers:

Provider	Host name	Server Port	Enable SSL
Yahoo	smtp.mail.yahoo.com	465	On
Hotmail/Outlook	smtp.live.com	587	Off
iCloud	smtp.mail.me.com	587	Off
163.com	smtp.163.com	465	On
Yandex	smtp.yandex.com	465	On

If there are no warning messages, the e-mail address is setup properly and you are ready to e-mail mini-reports from the field.

Failed Setup

If setup failed, possible reasons include:

1. Email address or password was entered incorrectly – try re-entering these fields.
2. Hostname, port or SSL setting are incorrect
3. Your email security settings **may need** to be adjusted, which may require you to login to your e-mail account from a PC or mobile device.

4.1.8 Screen Saver

A screen saver can be setup to turn off the DVL screen after a period of inactivity to save power. The Screen Saver can be set to turn the screen off after 1 minute, 5 minutes or never (OFF setting). Pressing this button cycles between those three options. When the screensaver is activated and the screen shuts off, touch anywhere on the screen to turn it back on again.

4.1.9 GPR Plot Options

Selecting this option will display the screen in Figure 4-8.



Figure 4-8: GPR Line Plot Options

- **Auto-Hide Buttons** - If this is set to ON, then in Line Scan mode, the buttons at the bottom of the screen disappear shortly after data collection begins, effectively enlarging the area for data display. The buttons will re-appear after a couple of seconds whenever the sensor stops moving forward, is in back-up mode or any button is pressed on the keypad.

4.1.10 Reset to Defaults

Selecting this option at the bottom of the screen will reset all settings & preferences back to the default settings (Figure 4-9). Pressing this will ask you to confirm the Reset to Defaults. If **Yes** is selected, the next screen will ask if you would like to remove all saved wireless networks and e-mails addresses.

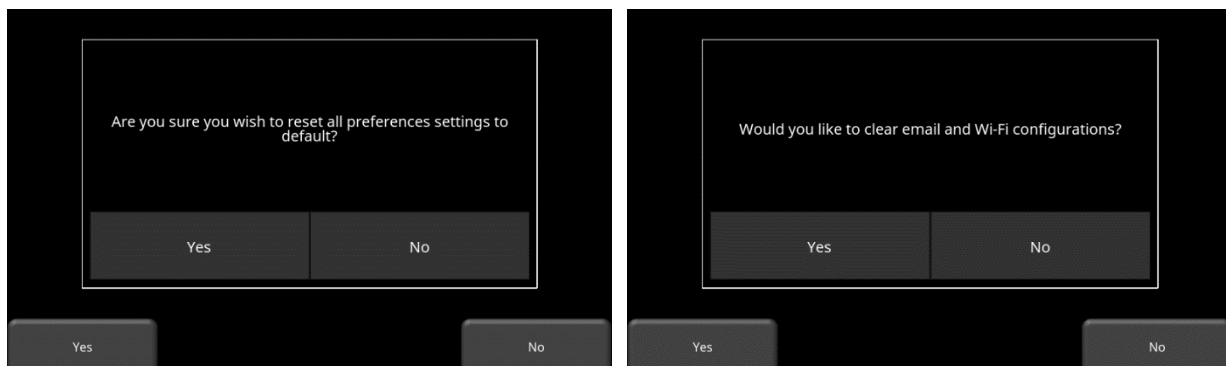

Figure 4-9: Reset to Defaults, a) Image on left is the first confirmation screen. b) If you press Yes, you will see the second confirmation screen on the right asking about deleting e-mails and Wi-Fi settings.

4.2 System Test

The system test sub-menu (Figure 4-10) allows the user to perform certain tests to ensure proper operation of the system. Select the component to test then press **Start**. After completing a test there is an indication of whether the system passed or failed the test. Each test is described below in more detail.

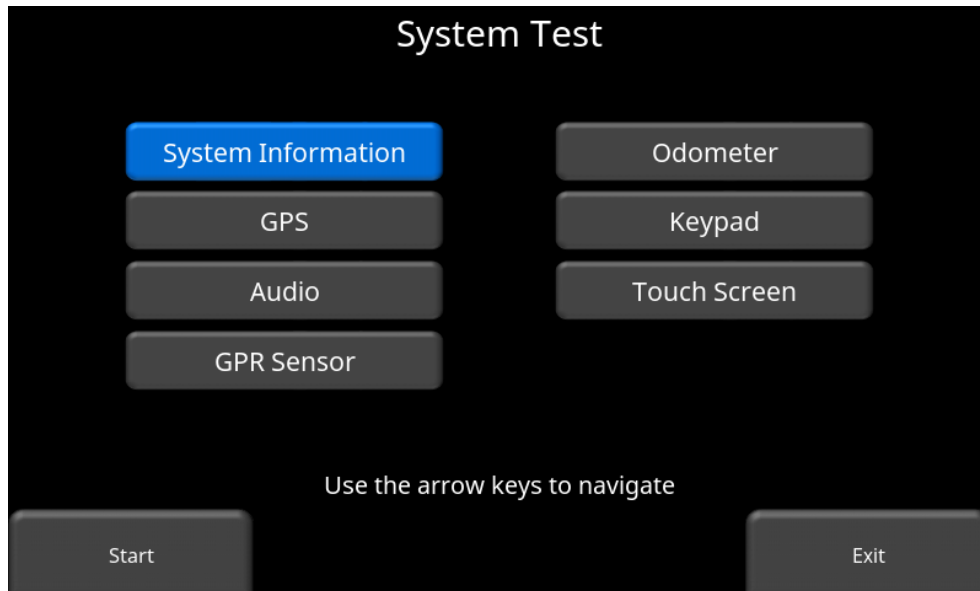

Figure 4-10: System Test menu

4.2.1 System Information

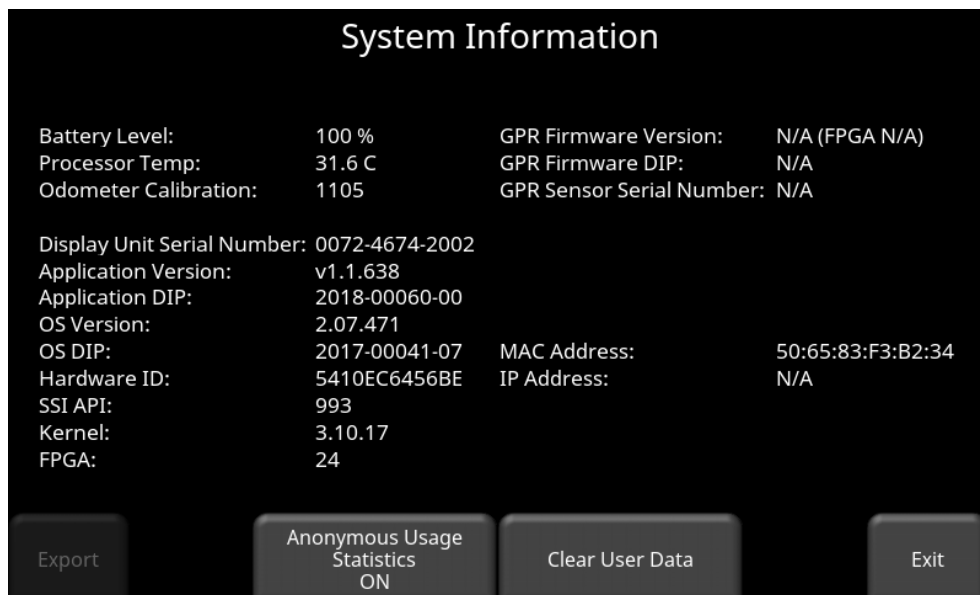

Figure 4-11: System Information

System Information is the only option in System Test which is not actually a test. Here information such as the version, serial numbers, temperature and battery power are displayed. (Figure 4-11). Pressing **Export** will just export a System Summary Report with this information to a USB stick. The Export button is greyed out, unless a USB stick is currently inserted.

There is an option called Anonymous Usage Statistics. When this is set to **ON** and the user is connected to a wireless network, any system malfunctions will trigger an automatic notification to Sensors & Software. This is to help with gathering information about any system irregularities. As the name suggests, the notification is completely anonymous and no personal information is sent.

Pressing **Clear User Data** will delete all saved GPR data, e-mail addresses, system configurations and preference settings. A message window will pop up asking you to confirm deletion. Press **Yes** to proceed with deletions or **No** to cancel (Figure 4-12).

Note: Clear User Data essentially wipes the system clean. Upon reboot, it will run the Setup Wizard, similar to when it's used the first time or after re-installing the firmware.

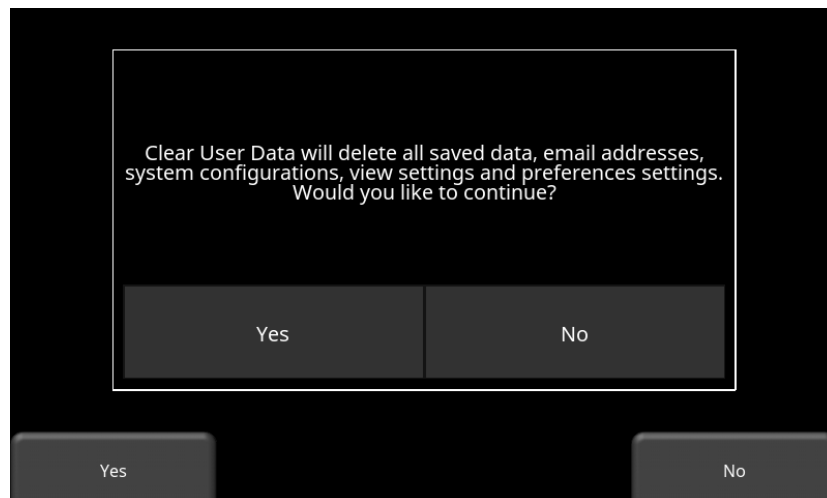

Figure 4-12: Warning message after pressing Clear User Data

4.2.2 Keypad

The keypad test ensures that all buttons on the membrane keypad are working. Press **Start** to begin the test which requires the user to press each button once, within a 20 second timeframe (Figure 4-13).

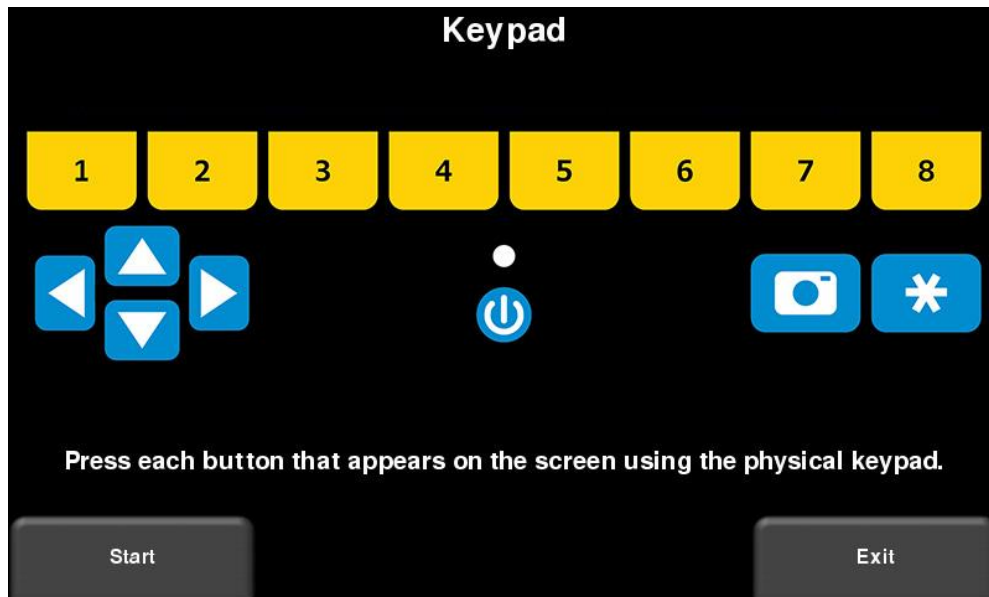

Figure 4-13: Keypad Test

Once that is complete, a short LED test will ensue, which checks the proper operation of the LED.

4.2.3 Audio

This test ensures that the speaking is operating properly. After starting the test, you should hear a sound with an increasing pitch.

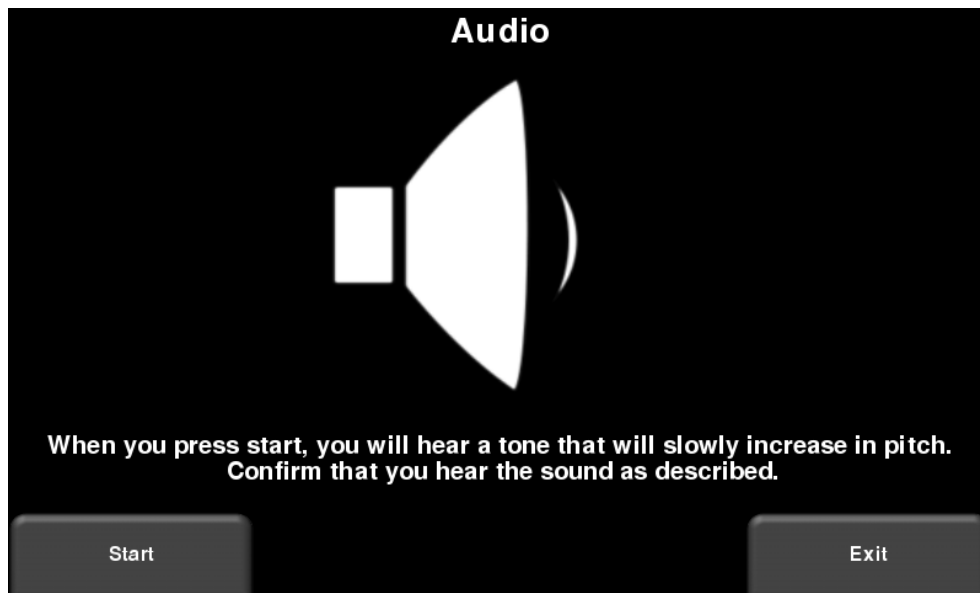

Figure 4-14: Audio Test

4.2.4 Touch Screen

The test checks proper operation of the touch screen (Figure 4-15). It allows you to test the screen (by pressing **Test**) or perform a quick calibration followed by a test (by pressing **Calibrate**). Both involve touching targets on the screen in the allotted time.

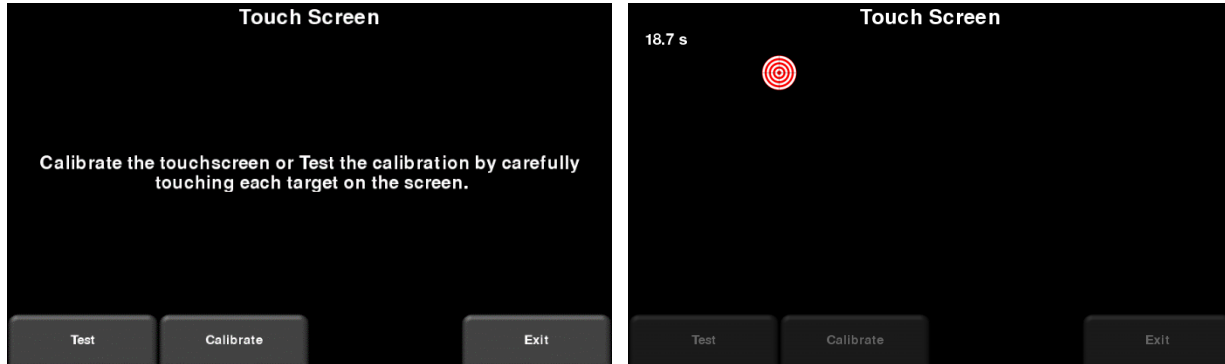

Figure 4-15: Touch Screen test on the left, Touch Screen calibration test on the right

4.2.5 GPR Sensor

This test checks proper operation of the GPR sensor, including the amplitude of the pulse. Once the cart is tipped backwards and start is pressed, it will conduct the test (Figure 4-16). If there are any irregularities, the test will indicate failure. However, if the test passes, it doesn't mean the system is working perfectly. A test line should be setup as a baseline, and results compared to the test line to validate proper performance and operation ([Section 13.6](#)).

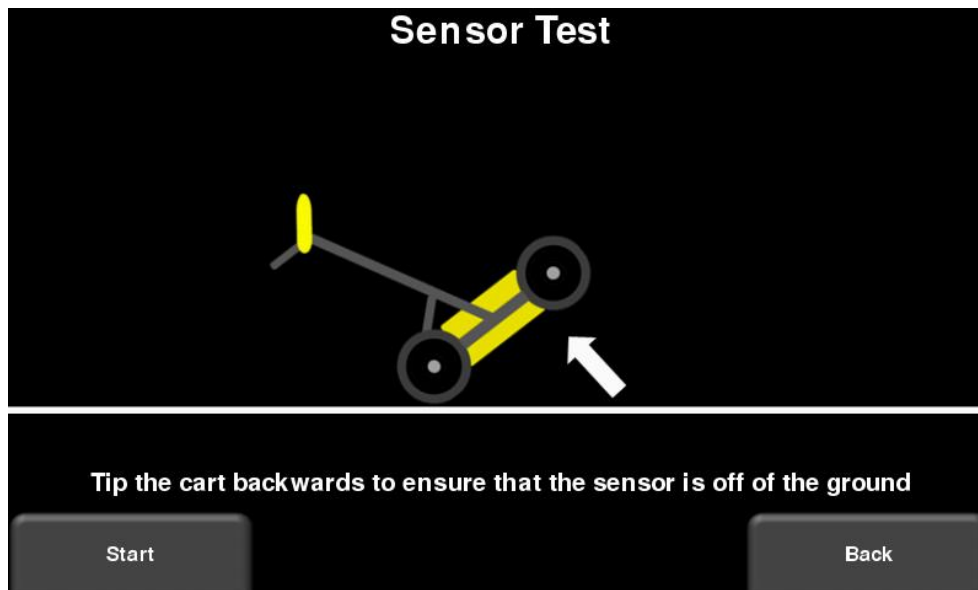

Figure 4-16: Sensor Test

4.2.6 Odometer

This test ensures that the odometer is calibrated properly for distance. Even though the odometer is calibrated in the factory, you must calibrate it periodically to ensure accuracy. This is particularly important as the calibration can change with different surface materials.

When selecting this option, you will see the screen in Figure 4-17. The following options exist:

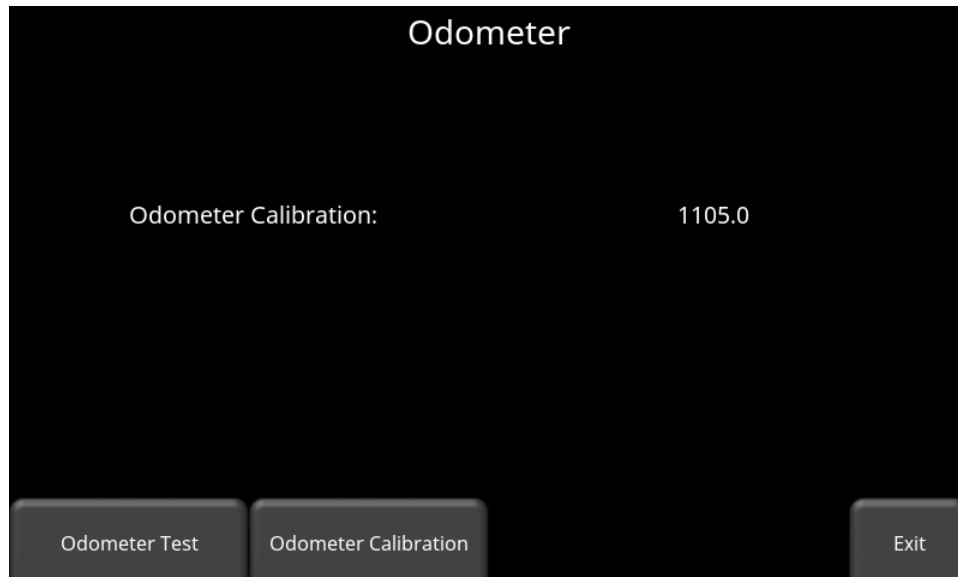

Figure 4-17: Screen displaying current odometer calibration

- **Odometer Test** – This test verifies the odometer is calibrated properly. It involves moving the system a set distance (5m or 10', depending on units used), and comparing the value obtained to a known value. The screen in Figure 4-18 will be displayed once Odometer Test is pressed. Press **Start** to begin and then press **Finish** when you've moved that distance. It will display a pass or fail, along with a percentage difference from the known value (Figure 4-19).

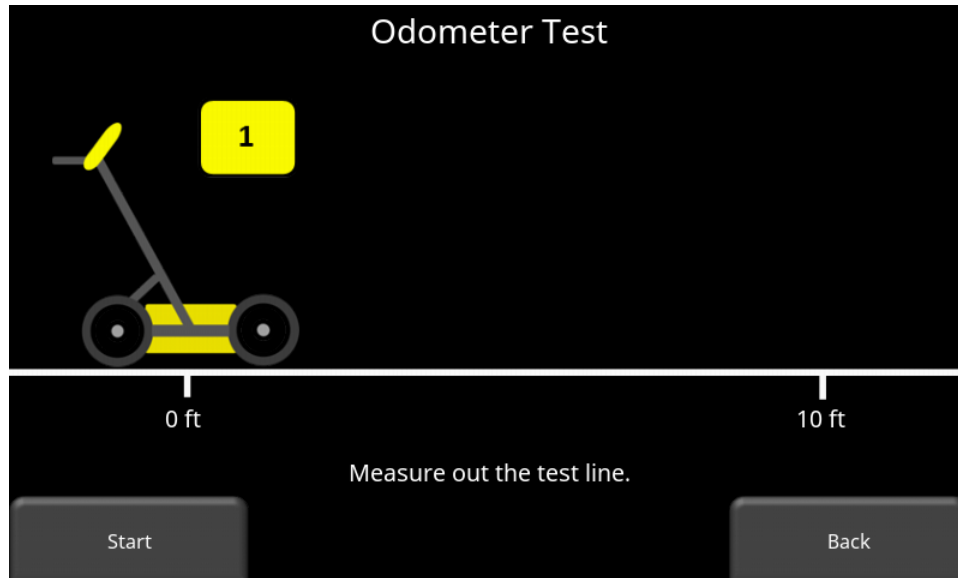

Figure 4-18: Doing an odometer test

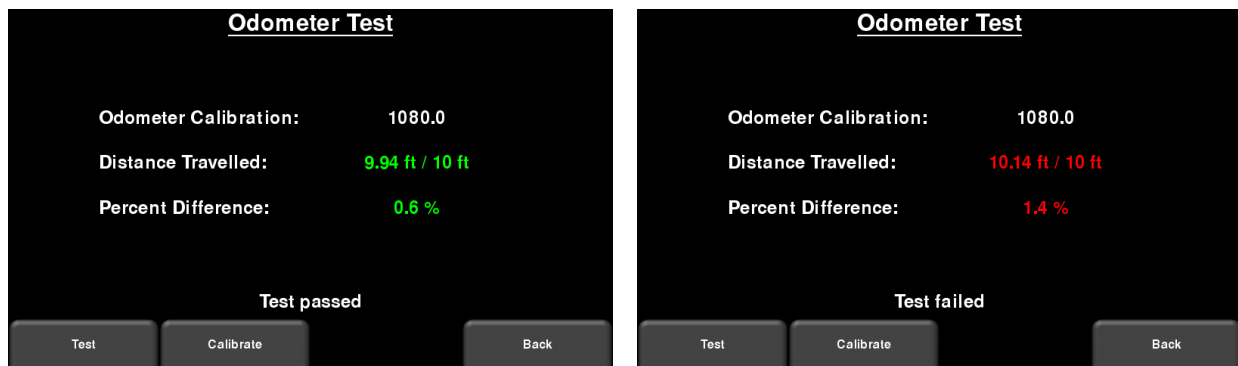

Figure 4-19: Odometer Test passed on left, failed on the right

- Odometer Calibration** - This option actually calibrates the odometer (Figure 4-20). Choose a set distance from the screen or select Custom. Then press **Start** and then move the system that exact distance, using a measuring tape or other known distance indicator. Press **Finish** when you have travelled that distance

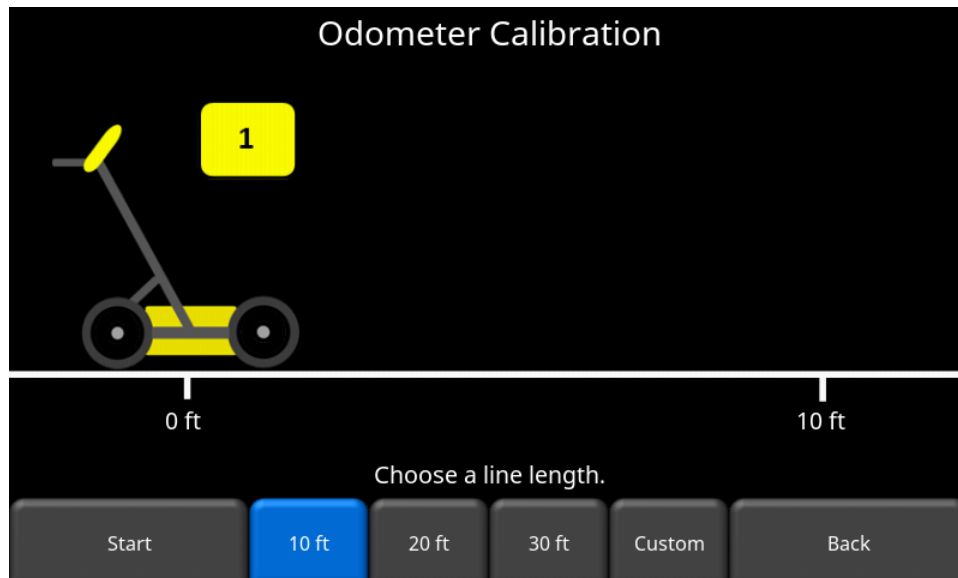

Figure 4-20: Odometer Calibration – select a distance and then press Start

Upon completion, it displays the screen in Figure 4-21 (left image). You can either accept the new value by pressing Accept or revert back to the previous value by pressing Reject. If the new value is significantly out of range, the test will fail Figure 4-21 (right image).

The odometer calibration value is stored in the Display Unit. If the Display Unit is changed, or swapped out, you will need to run the Odometer Calibration test again.

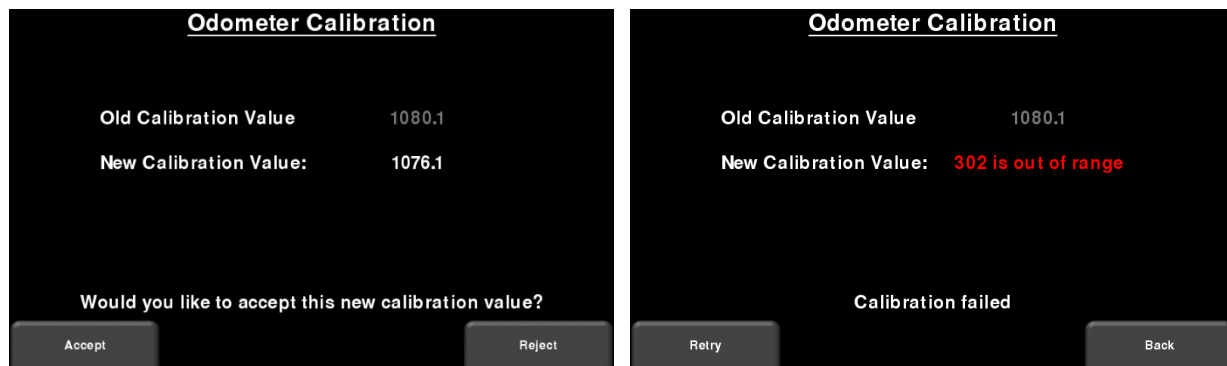

Figure 4-21: Results of Odometer Calibration (L). Image on right shows a failure, as calibration is way out of range

4.2.7 GPS

The DVL contains an internal GPS, but you also have the option to purchase an external GPS receiver from Sensors & Software. Alternatively, you may have your own GPS that you want to connect to the system. The GPS test will ensure that the system is communicating properly with the GPS and receiving data (Figure 4-22). It doesn't mean you are actually seeing satellites; the GPS test can still pass indoors with zero satellites visible. If the test fails, check the GPS cable is connected securely at both ends and the GPS is receiving power.



Figure 4-22: GPS Test

The basic position and time information is displayed on the screen. On the screen, the Fix Type notes if there are any corrections being applied, such as DGPS. When first going outside, give it a few minutes to track, or lock onto satellites.

Pressing **Strings** will display the raw data strings that are outputted by the GPS (Figure 4-23) as they scroll down the screen. The user may select this option to verify the GPS is outputting the proper NMEA string format.



Figure 4-23: GPS Strings

Pressing **Clear** will clear the strings. Pressing **Info** will return to the main GPS test menu.

Press **GPS Setup** to see the screen in Figure 4-24.

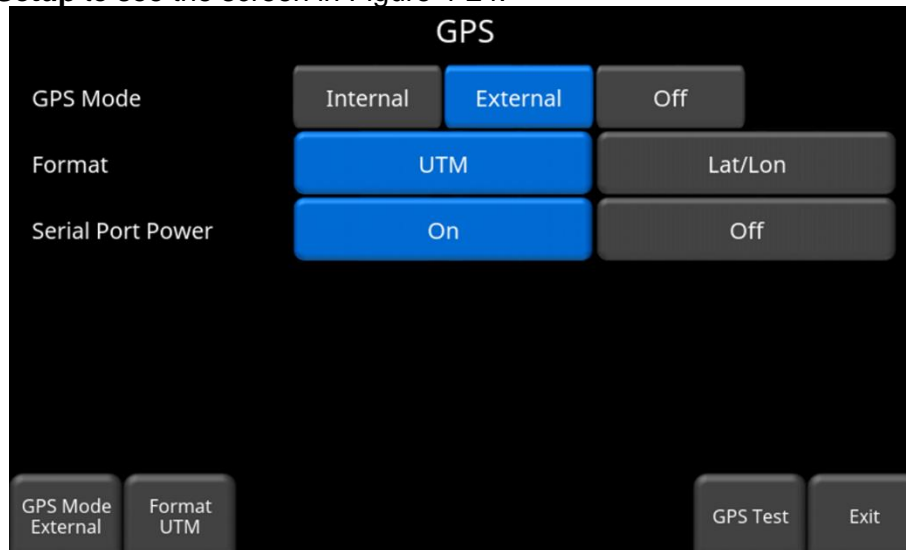

Figure 4-24: GPS Setup screen

The following buttons are explained below:

- **GPS Mode** –you can select whether to use the internal GPS, external GPS or no GPS at all (Off).

Note that, due to limited accuracy, the Internal GPS **cannot** be used to position Line Scans in MapView; only the External GPS will do this.

Ensure that you have the right GPS selected prior to your survey.

- **Format** – GPS units can be either UTM (Universal Transverse Mercator) or Latitude/Longitude coordinates
- **GPS Test** – pressing this will return to the screen in Figure 4-22
- **Serial Port Power** - the serial port on the back of the Display Unit can output power, thereby enabling a single cable to be used for the GPS (power and data). When you purchase a GPS from Sensors & Software, this cable is included. However, if you use a 3rd party GPS, you need to determine if the GPS can accept power via the serial port.

Pressing the **On** button will turn power to the serial port on, but it will display a warning message first (Figure 4-25). Press **Off** to disable power to the serial port.

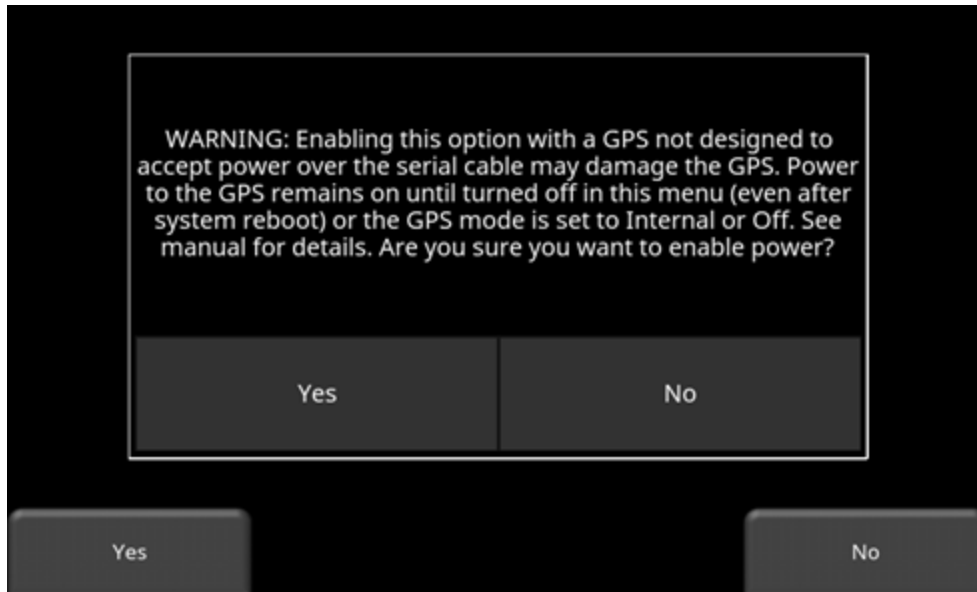

Figure 4-25: Warning message about enabling power to the serial port

4.3 File Management

Press **File Management** to enter this sub-menu. From here, the user can view screenshots, export data and delete all data (Figure 4-26).

File Management		
	Project 1	Total
Projects:		1 / 9
Grids:	0 / 10	0
Lines:	1 / 99	1
Screenshots:	0 / 1000	0
External Drive:	Disconnected	
Disk Usage:	0.0 %	6.6 %

Navigation buttons at the bottom: - Project +, Screenshot Gallery, Map View, Delete Project, Export Data, Exit

Figure 4-26: File Management displays the lines, grids and screenshots for a given project in the middle column. The right column displays the total for each that are saved on the system.

A description of each of the buttons is given below:

4.3.1 Screenshot Gallery

This allows the user to view all screenshots that were saved by pressing the Camera button (Section 11.1). The display will show a Tile View of four screenshots per page (Figure 4-27). If there are more than four screenshots, swipe the screen from right to left to view the rest. Alternatively, you can also use the **Left** and **Right** arrow keys on the 4-way directional keypad

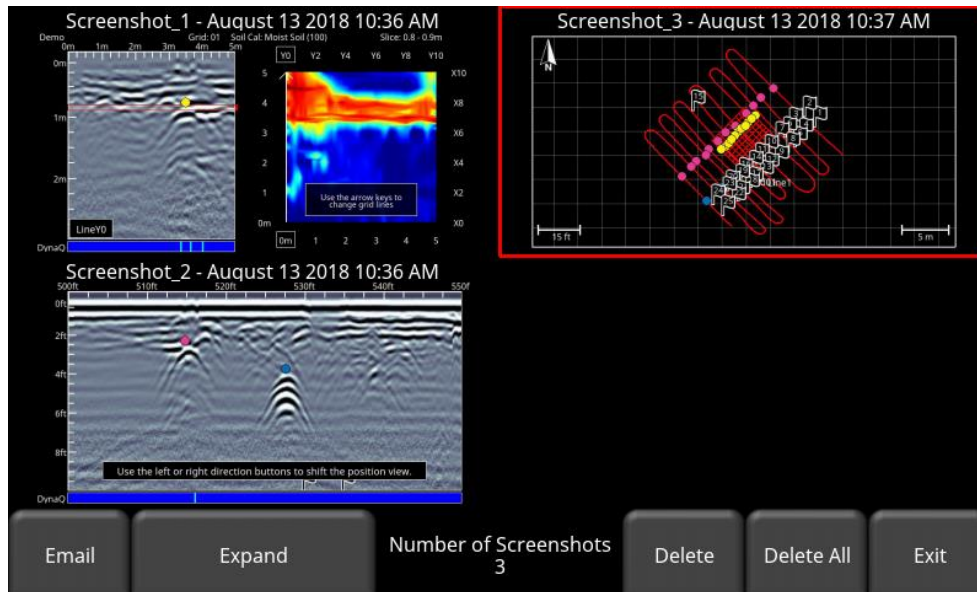

Figure 4-27: Tile View in Screenshot Gallery

From the Tile View, the user has the following options:

- **E-mail** – pressing this button will e-mail the selected screenshot (provided you are connected to a wireless network and have setup an account to send from). You will be prompted to enter a destination e-mail address, or you may use the most recent one which will be listed by default. Pressing the “...” button to the left of the e-mail address displays the last 5 e-mail addresses used, allowing the user to easily select a recently used email address, rather than re-entering it.
- **Expand** – press this button to show the selected screenshot as a full screen image. On the subsequent screen, press **Tile View** to return to the screen displaying four screenshots per page.
- **Delete** – pressing this button will delete the displayed screenshot. There will be a confirmation message asking if you are sure. Press **Yes** to proceed.
- **Delete All** – pressing this button will delete all screenshots. There will be a confirmation message asking if you are sure. Press **Yes** to proceed.

4.3.2 Delete Project

Pressing this will delete the currently selected project. There is a confirmation window asking if you are sure; press Yes to continue deleting, press No to cancel.

4.3.3 Map View

Pressing this will display a map view for all the data (lines & grids) in a given Project (Figure 4-28). For collected grids, Map View is enabled if a GPS (internal or external) was on during data collection. However, for lines, Map View will only be enabled if an external GPS was used. Map View shows the survey path travelled, as well as any flags or interpretations added to the data. Map View is fully explained in [Section 9](#).

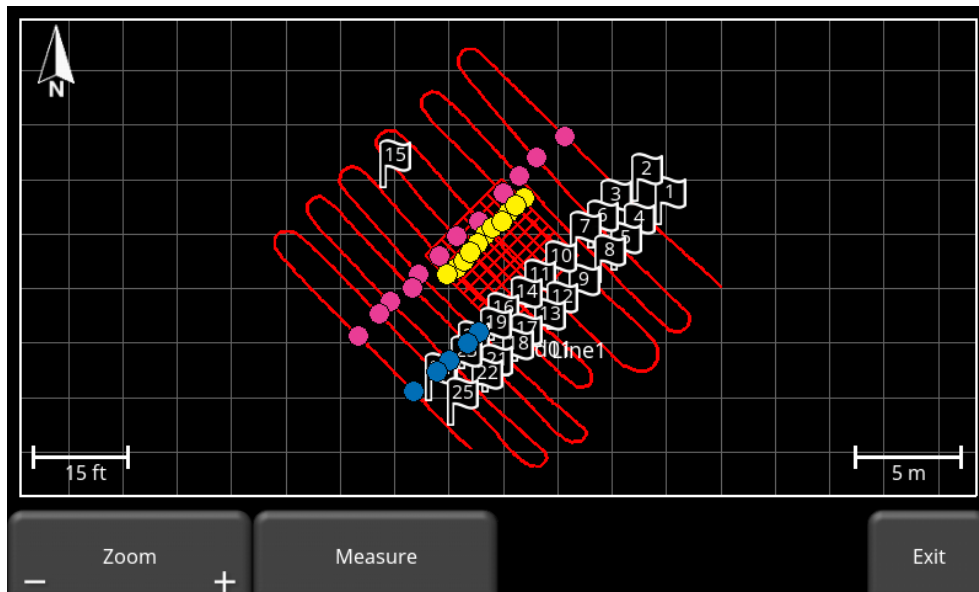

Figure 4-28: Map View showing two grids and a long line with interpretations. Map View is enabled because the data was collected with GPS.

4.3.4 Export Data

Screenshots and data are always saved to the internal memory of the Display Unit. If a USB-drive (memory stick) is inserted into the USB port on the Display Unit, pressing the **Export Data** button will copy all the data files to the USB-drive. If no USB-drive is inserted, this option will not be accessible.

Data can also be exported anytime a USB drive is inserted into the USB port, regardless of what menu you are in. This is further explained in [Section 12](#).

5 GPR Concepts

5.1 Theory

Ground penetrating radar (GPR) technology uses radio waves to image objects in the subsurface. The subsurface may consist of soil, rock, asphalt and other materials. GPR systems emit high frequency radio wave pulses and detect the echoes that return from objects within the subsurface. Echoes are produced when the target material is different from the host material (e.g. PVC pipe in gravel)

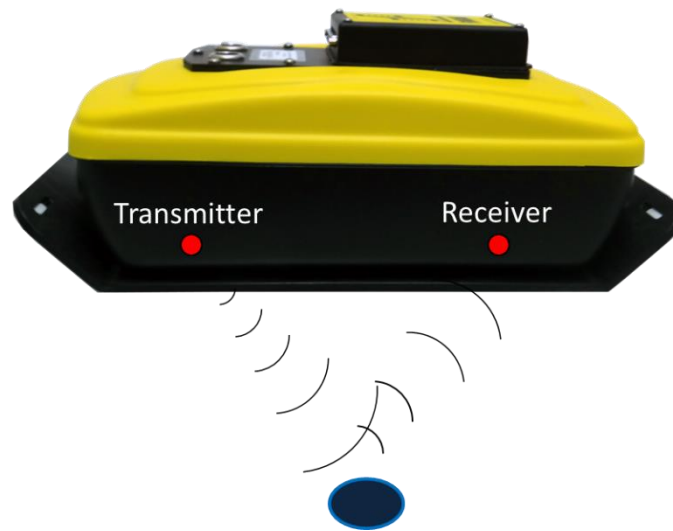

5.2 Hyperbolas

The GPR display shows signal amplitude versus depth (time) and sensor position along a line. This is called a “Line Scan”. Since radar energy radiates in a 3D cone shape rather than a thin beam, a **hyperbola** (or inverted U) is the GPR response from a small point target like a pipe, rock, or a tree root. The radar wave hits the object before and after going over it and forms a hyperbolic reflection that can appear on the record even though the object is not directly below the radar:

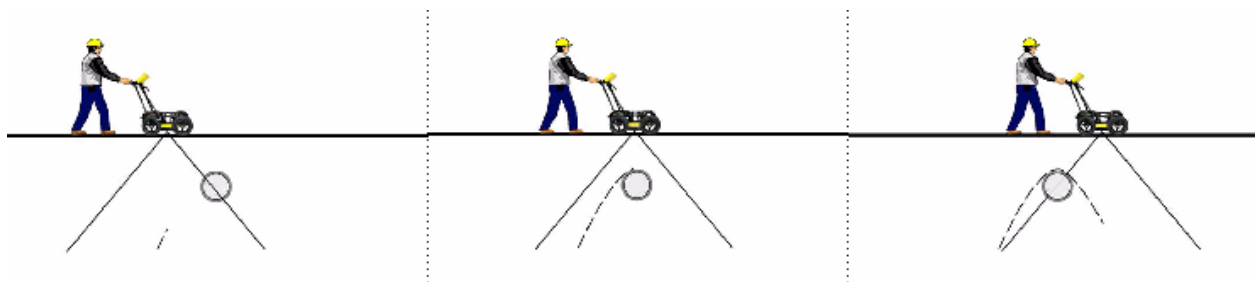

Hyperbolas are best viewed when subsurface targets are crossed perpendicularly (at a 90 degree angle). The actual position of the object is located at the apex of the hyperbola.

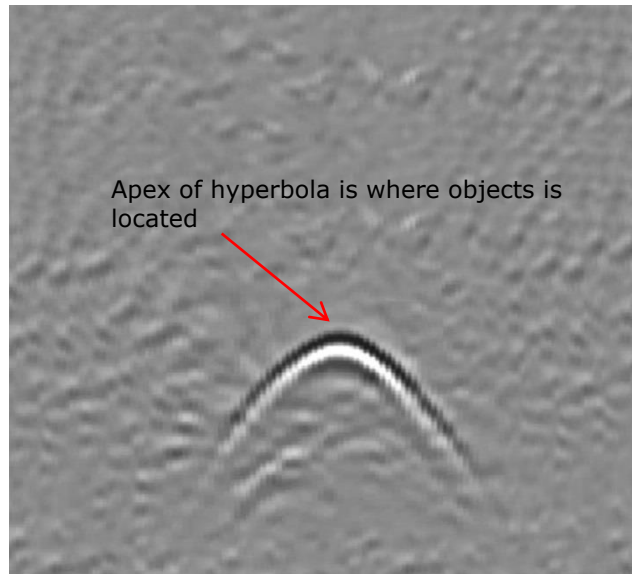

5.3 Calculating Depth

Ground penetrating radar records the time it takes a radio wave to travel to a target and back; it does not measure the depth to that target directly. Depth to target is calculated based on the velocity with which the wave travels to the target and back.

To calculate depth:

$$D = V \times T/2$$

Where D is Depth

V is Velocity

T is the Two – way travel time

Velocity is indicated by the Soil Calibration Value, known as Soil Cal. Once the Soil Cal values are set, the measured depths will be determined accurately ([Section 6.6.5](#))

5.4 Soil Calibration values

Below is a table of common subsurface materials and their corresponding Soil Cal. This is only a guideline and there is some variation based on the fact that there can be a mixture of different materials in the subsurface. By far, the soil water content has the biggest influence on Soil Cal values.

Material	Soil Cal
Air	300
Ice	160
Dry Soil	140
Dry Rock	120
Soil	100
Wet Rock	100
Concrete	100
Pavement	100
Wet Soil	65
Water	33

5.5 Air Waves

Some hyperbolas are caused by air wave reflections from objects above ground, such as posts, fences, overhead wires, and trees.

The following image displays how air wave reflections affect data:

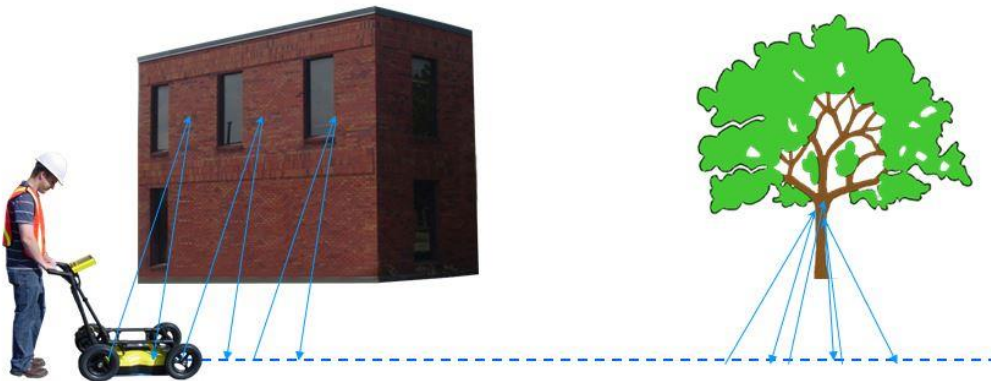

An important part of understanding the data image is learning to recognize these unwanted "air" targets and distinguish them from the targets in the ground. Good field notes are indispensable for helping identify unwanted events on the data.

The best way to identify air reflections is the target hyperbola method. Hyperbolas from above ground objects are wider than objects in the ground and will have a Soil Cal at, or close to, 300.

To learn more, see Soil Cal ([Section 6.6.5](#)).

6 Line Scan

Line Scan mode allows the operator to acquire data along a straight line and examine it as a cross-section image. The operator can locate a feature and easily back-up and mark the location of that object on the ground. Line Scan mode can also be used to get accurate depth measurements.

Ensure you are in the appropriate project before entering this mode.

From the main screen, press the **Line Scan** button; you will see the screen shown in Figure 6-1.

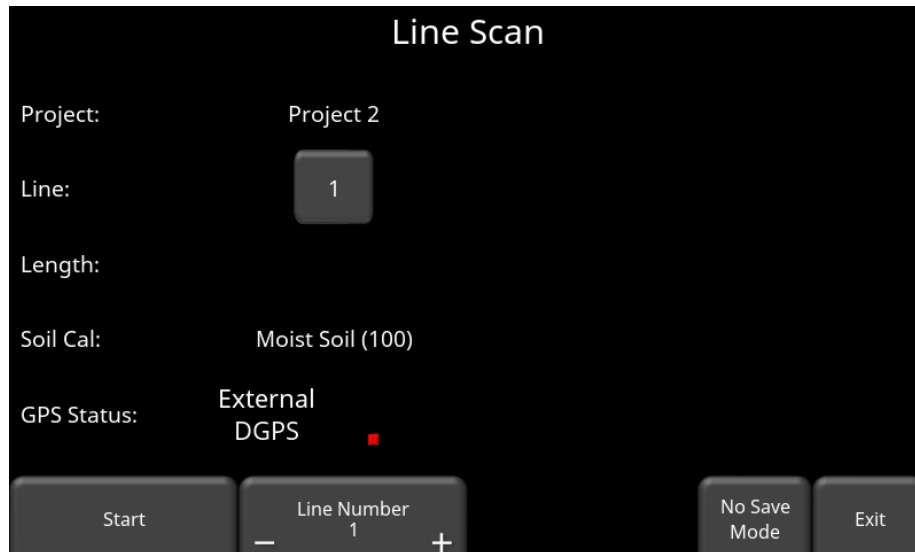

Figure 6-1: Preparing to Line Scan

The GPS Status indicates which GPS is currently selected, as well as the quality of the GPS signal, which is based on the number of satellites that it sees. The chart below explains what the colours and bars mean:

Indicator Color	# of bars	# of Satellites
Red	1	4
Orange	2	5
Green	3	6,7
Green	4	8,9
Green	5	10+

Note that if you select Internal GPS, it does NOT position any line scans in MapView; only the External GPS will do this. Ensure that you have the right GPS selected prior to your survey.

6.1 Selecting a line

To select the desired line, press the **+** and **-** buttons under **Line Number** on the bottom of the screen. Alternatively, pressing the line number button itself will show the screen in Figure 6-3. From here, you can go directly to any line number. If the line number is white, then that line is empty, whereas lines that already contain data are shown in red.

To collect data without saving it, press **No Save Mode** ([Section 6.6.7](#)). Any data collected will NOT be saved, but screen shots can still be taken with the **Camera** button. These screen shots get placed in the currently selected project.

If the line number is white (Figure 6-1), Press **Start** to enter data acquisition. All data collected will be saved under this line number.

If the line number is shown in red (Figure 6-2), you will see the data preview on the right side of the screen. If it's a long line, only the last part of the data will be shown. From this screen, you will have the following options available:

- **View** – press this button to review the currently displayed line.
- **Delete** – pressing this will delete the line. It will prompt you to confirm before deleting.

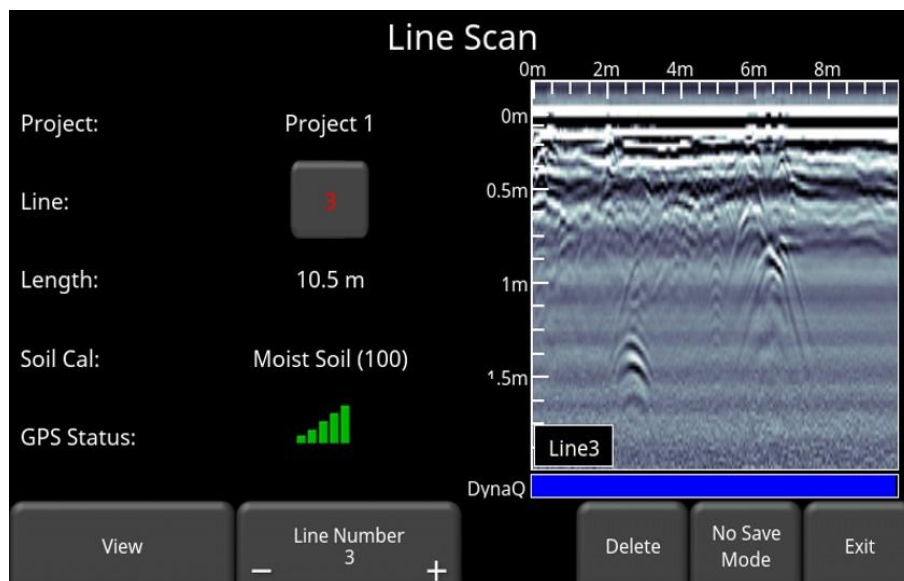

Figure 6-2: Line Scan mode, showing a line that was previously collected

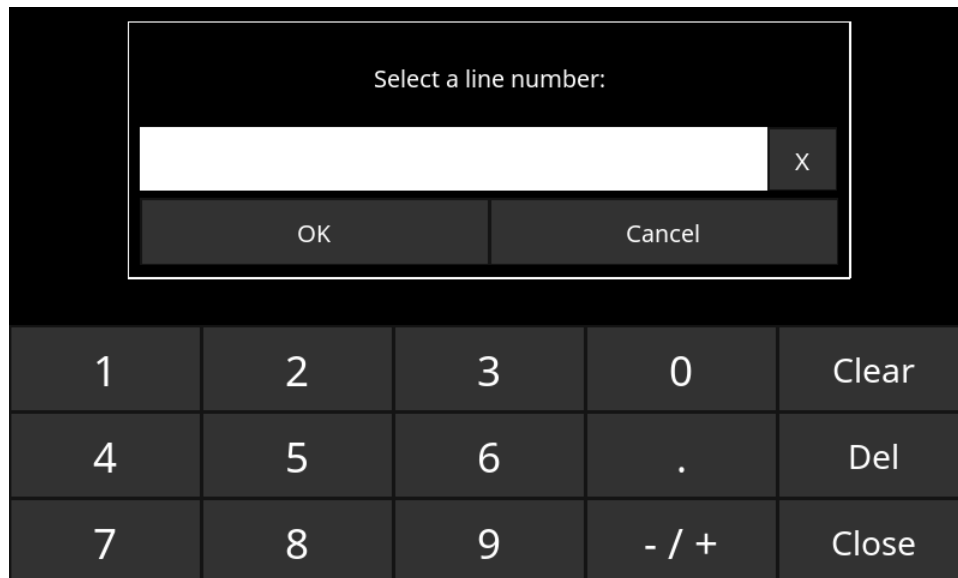

Figure 6-3: When the button showing the line number is pressed, this screen allows the user to directly input the line they wish to go to

6.2 Acquiring Data

Press the **Start** button to begin collecting data. The screen will change to the data acquisition screen. As the system is pushed along a straight line, the collected GPR data scrolls onto the screen from the right and moves to the left (Figure 6-4).

The depth scale along the side of the GPR Line image and the position scale along the top of the image are set to Metric or US Standard units based on the setting in the Preferences menu ([Section 4.1](#))

If Auto-Hide Buttons is set to ON ([Section 4.1.9](#)), the menu at the bottom of the screen disappears as soon as you start collecting new data, thereby maximizing the data display area. When the user stops, backs up or presses a button on the keypad the menu reappears.

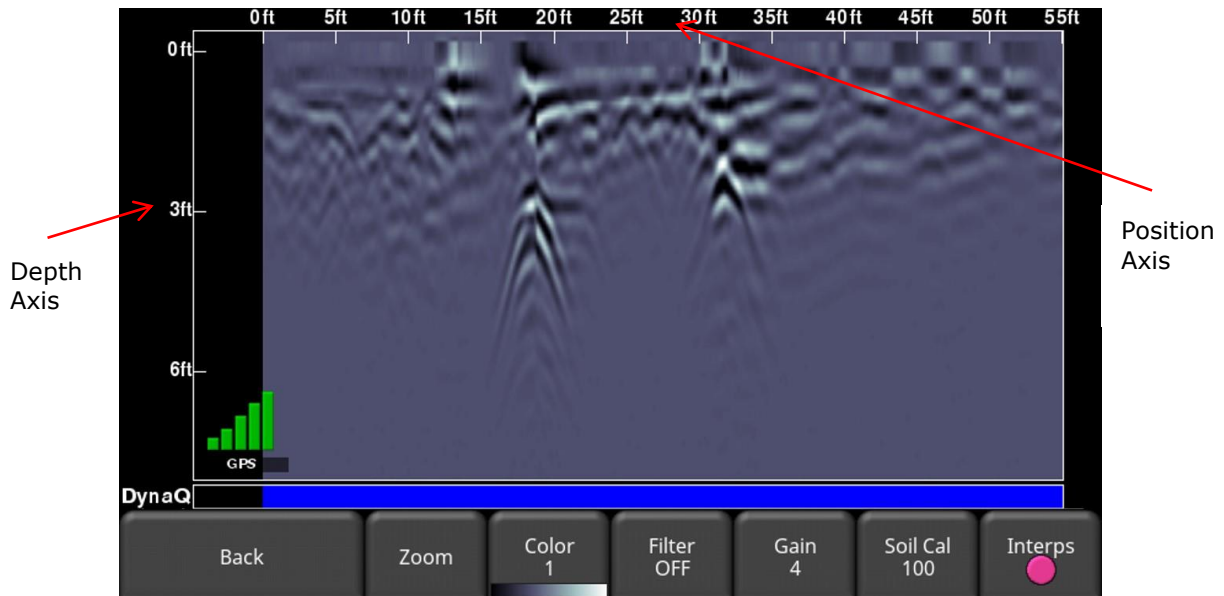

Figure 6-4: Line Scan acquisition mode, showing collected data and axis labels. DynaQ® indicator is shown at the bottom above the menu options.

6.3 DynaQ®

The system uses DynaQ®, an advanced patented technology that adjusts data quality as the system movement speed varies. In most situations, moving the system at a comfortable walking speed generates data of good quality. In situations where target resolution or maximum penetration depth is critical, moving slower increases data quality.

As the Line Scan data scrolls on the screen, the DynaQ® Index Bar is displayed along the bottom of the screen (Figure 6-4). The color of the bar indicates the quality of the data at that point along the line:

White	= No Data (too fast!)
Yellow	= Moderate quality
Light blue	= Better quality
Dark Blue	= Highest quality

In general, avoid collecting data at extremely high speeds.

6.4 Back-up Indicator

Line Scan mode incorporates a back-up feature to enable you to accurately locate targets and mark them on the ground. After acquiring some data on the screen, move the system backwards (Figure 6-5a). During back-up mode, there will be two indicators:

- **Position Indicator:** The red vertical line corresponds to the location at the center of the GPR sensor. As you pull the cart backwards, the Position Indicator moves to mark the current location of the cart in the image and a box appears with the current position, relative to the start of the line, listed as the top number.

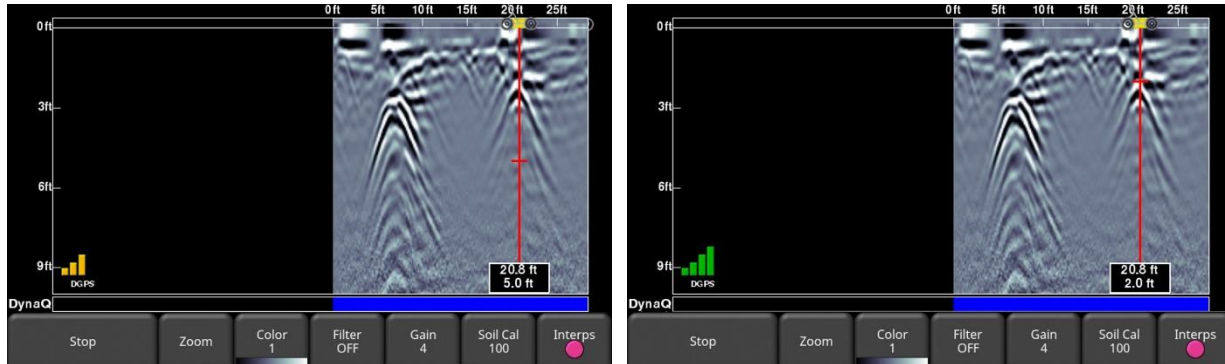

Figure 6-5: a) Back-up Indicator, b) Moving the Depth Indicator to the top of the hyperbola

- **Depth Indicator:** A short red horizontal line corresponds to the current depth value, as shown in the bottom number in the box. To determine the depth of an object, move the indicator up or down by dragging the horizontal line to the desired location (Figure 6-5b). Alternatively, you can also use the **Up** and **Down** arrows on the 4-way directional keypad. Note: make sure you have done a Soil Cal to ensure depth accuracy ([Section 6.6.5](#)).

To locate a feature, simply roll the system back along the same path until the red vertical line is exactly over the response (usually a hyperbola). You can mark the location of the object on the surface and continue data collection. Once you reach the point where you initially started backing up, the system will continue acquiring new data.

You can also obtain depth and position information anywhere on the Line Scan by touching the screen and holding for a second. A cross-hair appears where you touched the screen, with a box displaying the position and depth (Figure 6-6). To get the position and depth information about a different point on the screen, simply touch and drag the box or cross-hair to the desired position.

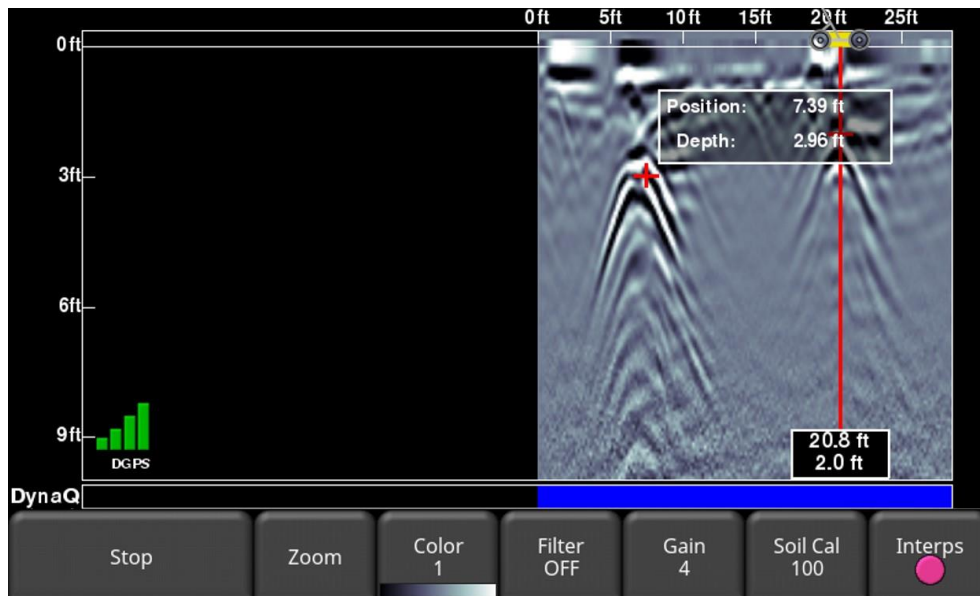

Figure 6-6: Touch screen to get depth and horizontal position at any point

Pressing Stop ends the line. This line is saved internally on the system and cannot be added to. Use the Left and Right directional arrow buttons to scroll and view data not currently displayed on the screen.

6.5 Flags

Flags are often inserted to mark noteworthy surface features, such as poles, sidewalks, changes in terrain etc. These markers may help you correlate subsurface targets with above ground features.

Pressing the **asterisk** button on the keypad will insert a flag at your current position, either during forward data acquisition or when backed-up. Flags are sequentially numbered (Figure 6-7).

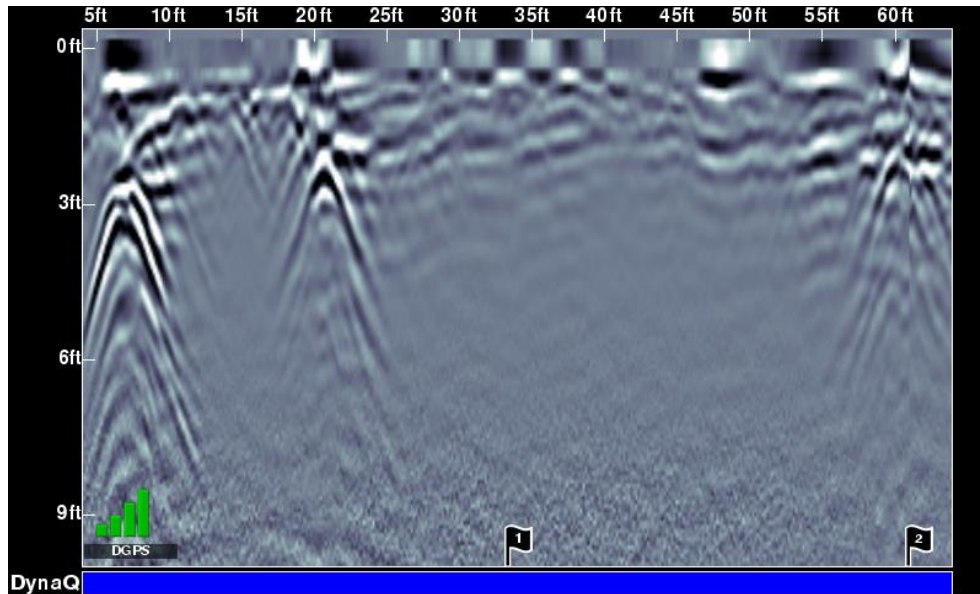

Figure 6-7: Inserting Flags

6.6 Line Scan menu options

All the settings described below change the way the data is viewed on the screen. They do not alter the saved data in any way. These settings can be changed while you are still collecting data, after you have pressed Stop, or when viewing a previously saved line.

6.6.1 Zoom

This button controls the horizontal and vertical scaling of the displayed GPR data. Pressing the **Zoom** button changes the buttons on the bottom menu, which are explained below:

- **Depth** – Pressing **+** and **-** under the **Depth** button allows you to change the display depth of the data. This is commonly referred to as the depth window. The pre-set values range from 0.5m to 2m (2' to 8'), see Figure 6-8.

If the data was collected with a shallower depth, the depth setting can still be increased after the fact, when reviewing the data. In general, it's a good idea to set your displayed depth to 1.5 - 2 times the depth you expect the deepest target to be.

- **Position** – Pressing **+** and **-** under the **Position** button allows you to change the length of data display on a single screen. This is also known as horizontal scaling. The pre-set values range from 5m to 30m (10' to 75'), see Figure 6-9. One reason for setting this to 30m would be to fit more data on the screen and look for anomalies relative to the surrounding soil.

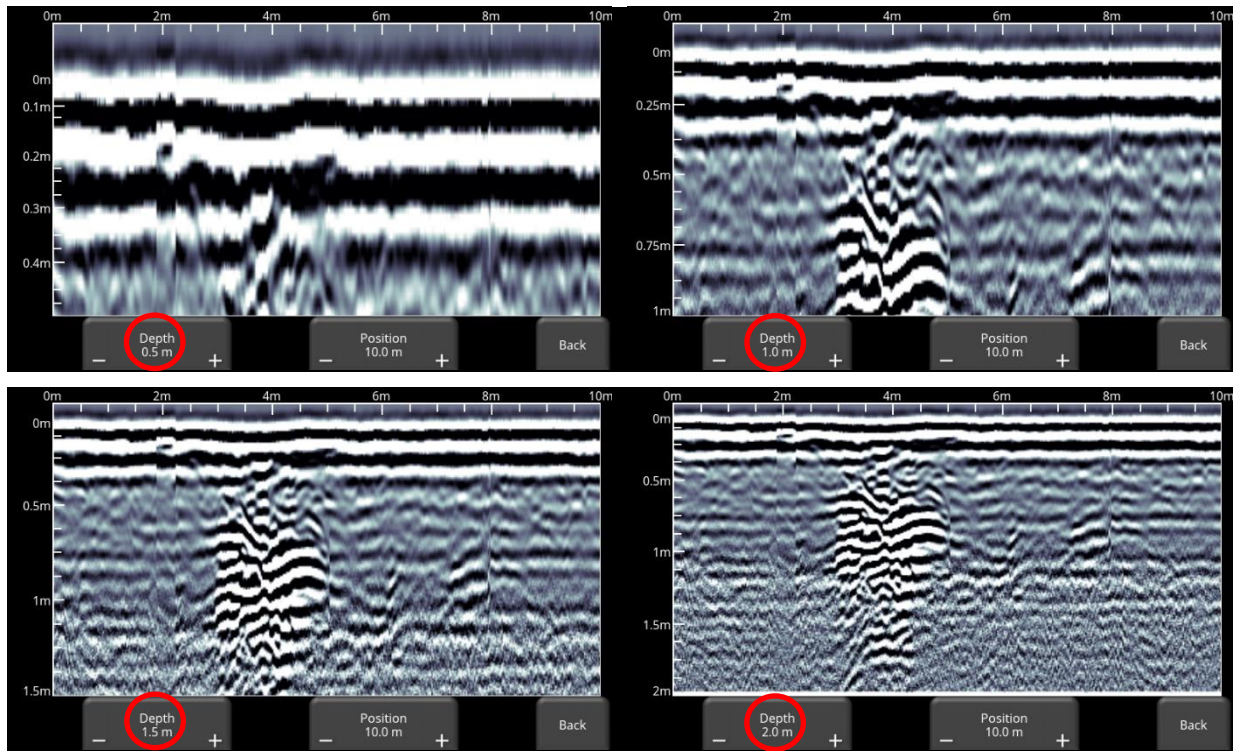

Figure 6-8: Varying displayed depth

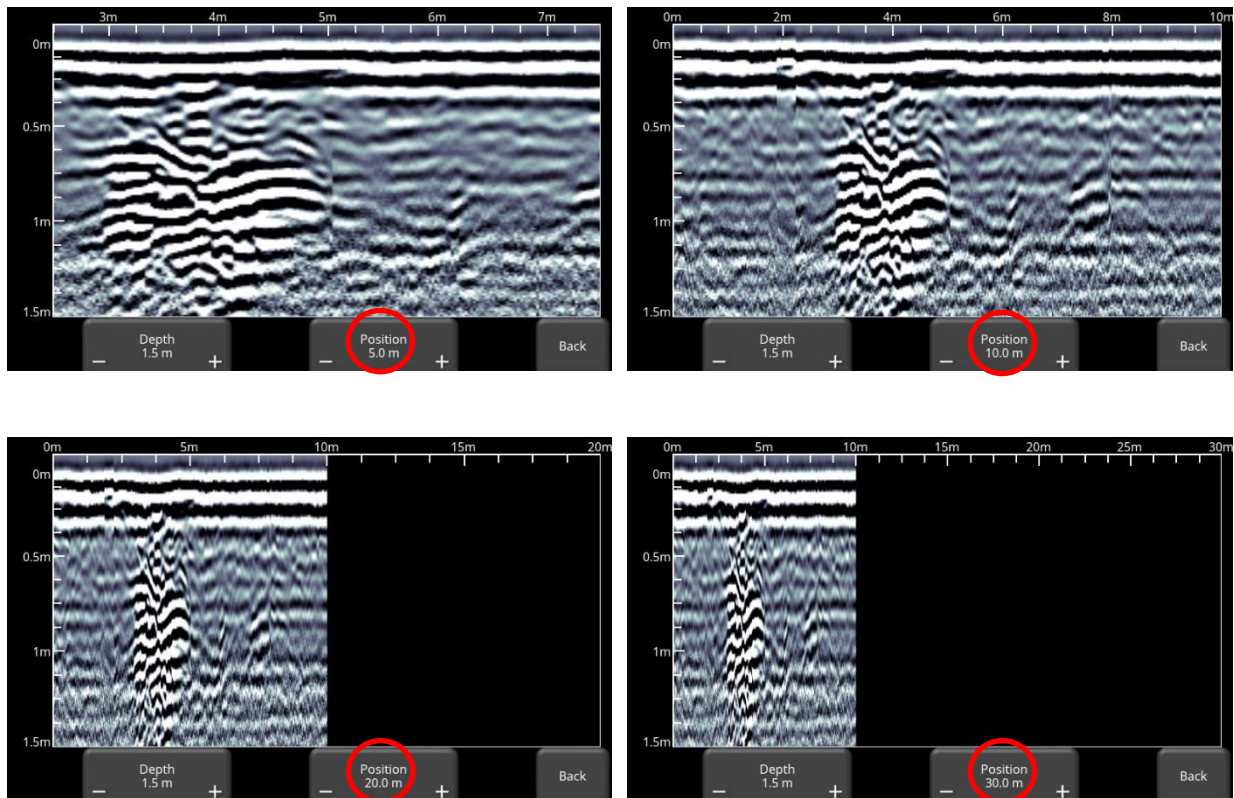

Figure 6-9: Varying position, or horizontal scaling

6.6.2 Color

Pressing this changes the color palette for the GPR Lines. There are 9 different color palette options. The image is automatically re-displayed as the color palette changes. A few sample color palettes are shown in Figure 6-10.

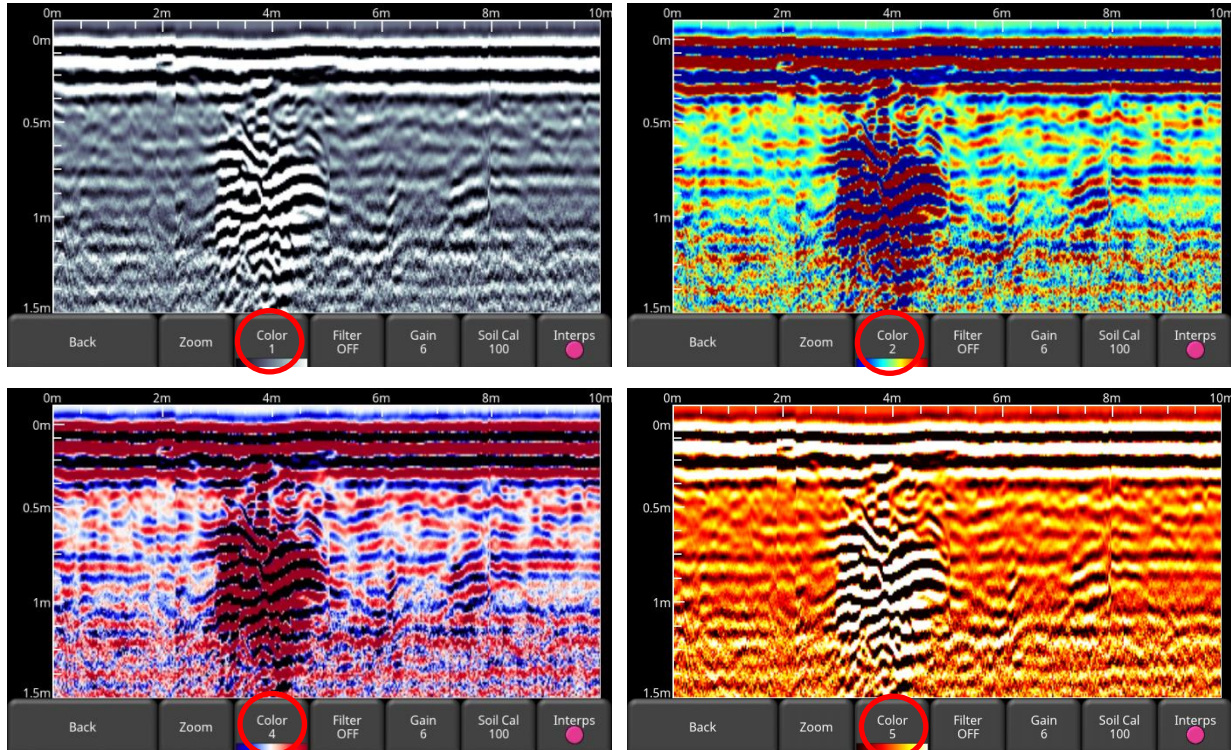

Figure 6-10: Changing Color palettes

6.6.3 Filter

The Filter is a background subtraction filter used for removing flat-lying responses in the data. Filtering helps identify shallow targets that might be masked by the strong signals at the top of the image, as well as possibly enhancing the visibility of hyperbolas further down in the data. However, it will also filter out other flat-lying responses, such as soil boundaries, so be careful when using this option if your target is flat.

It works by applying a running-average background subtraction to the data set, defined by the filter width or a window. This window “moves” across the data and the result is subtracted for every trace in the data set. The Filter is variable and pressing this button cycles between **OFF** and values **1** to **5** (Figure 6-11).

The lower the number, the longer the filter width, and the more “relaxed” the filter. Only the longer flat-lying features get removed.

The higher the number, the shorter the filter width, and the more “aggressive” the filter. This results in the removal of long and short flat-lying features.

Pressing **OFF** turns the filter off completely.

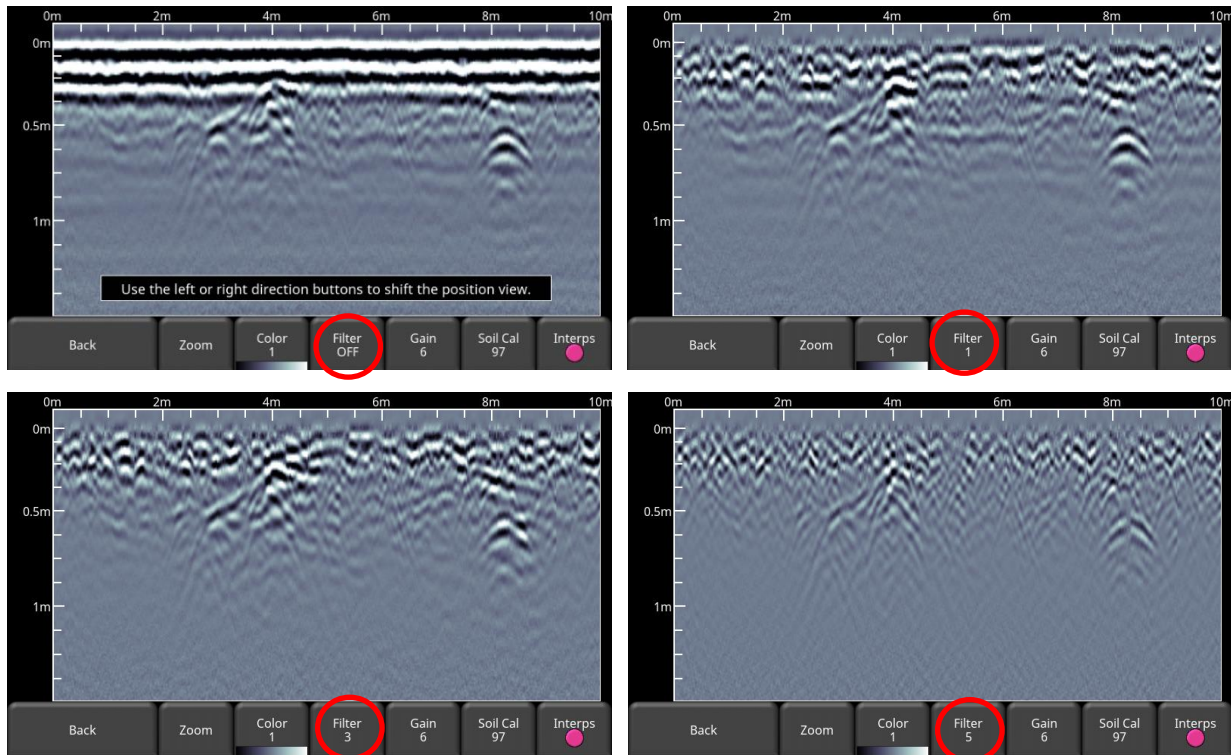
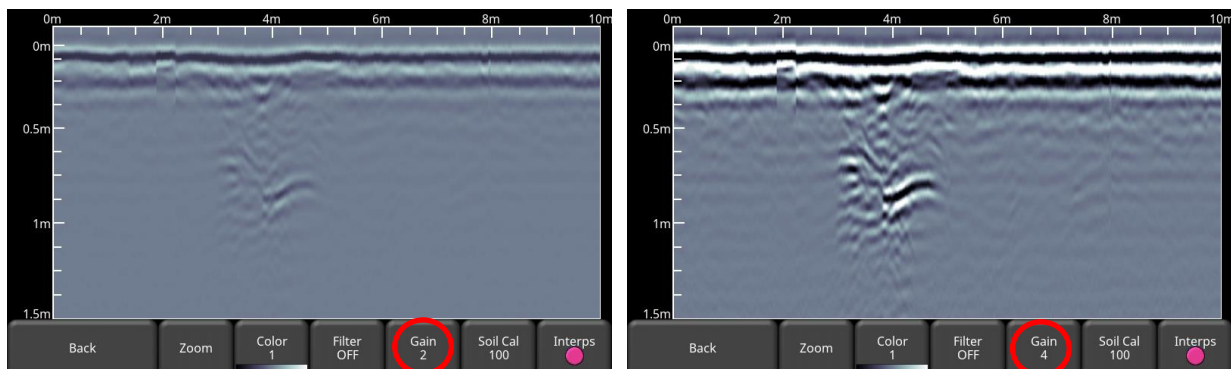

Figure 6-11: Showing Filter Off, variable filter lengths.

6.6.4 Gain

Since the material being scanned absorbs the GPR signal, deeper targets return weaker signals. Gain acts like an audio volume control, amplifying signals and making deeper targets appear stronger in the image. Gain values vary from 1 to 9 where 1 means a minimal amplification has been applied and 9 means that maximum amplification has been applied. Pressing this button increments the gain; once you reach 9 it cycles back to 1. Avoid over-gaining the data as it can make interpretation difficult (Figure 6-12). In general, soils that are more electrically conductive (e.g. clays) will require a higher gain compared to soils that are less electrically conductive (e.g. sand).



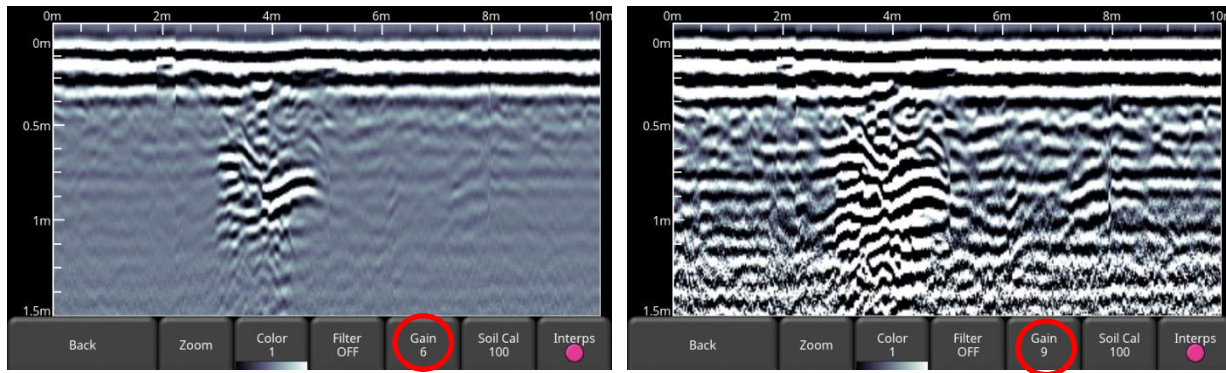

Figure 6-12: Varying the Gain

6.6.5 Soil Cal

The Soil Cal (also known as velocity) is a parameter used to ensure that measured depths are accurate. The best way to ensure this is by using the hyperbola-fitting method, since it is based on data collected in the area.

Crossing a linear target (e.g. pipe) at a 90 degree angle or a localized object (e.g. box) will produce a hyperbola suitable for soil calibration. The Soil Cal value obtained will be used to compute a depth estimate of a target. These depths will be *incorrect* if the soil type is calibrated on a target hyperbola produced at an oblique angle, rather than 90 degrees.

Once you have a hyperbola on the screen from a subsurface target, press **Soil Cal**. The menu at the bottom of the screen will change, giving you the option of specifying a Soil Type or adjusting the Soil Cal using the hyperbola-fitting method (Figure 6-13). These options are explained below:

- **Soil Types** – If there are no targets to calibrate to, and you know the type of soil, press this button to vary between the following mediums, with the pre-set Soil Cal value shown in brackets:
 - very wet soil (60)
 - wet soil (80)
 - moist soil (100)
 - dry soil (120)
 - very dry soil (150)
 - air (300)
- **Soil Cal** – allows you to use hyperbola-fitting to determine a more accurate Soil Cal. The options are slightly different, depending on whether or not you are in backup mode.

If the backup indicator is on the screen when you press Soil Cal, then you can only adjust the vertical position of the horizontal scroll bar, since it is presumed you have backed-up so that the system is right over the hyperbola in question. The scroll bar can

be moved up and down by touching the screen and dragging it, or using the up & down keypad arrows such that it lines up with the top of the hyperbola in question (Figure 6-13).

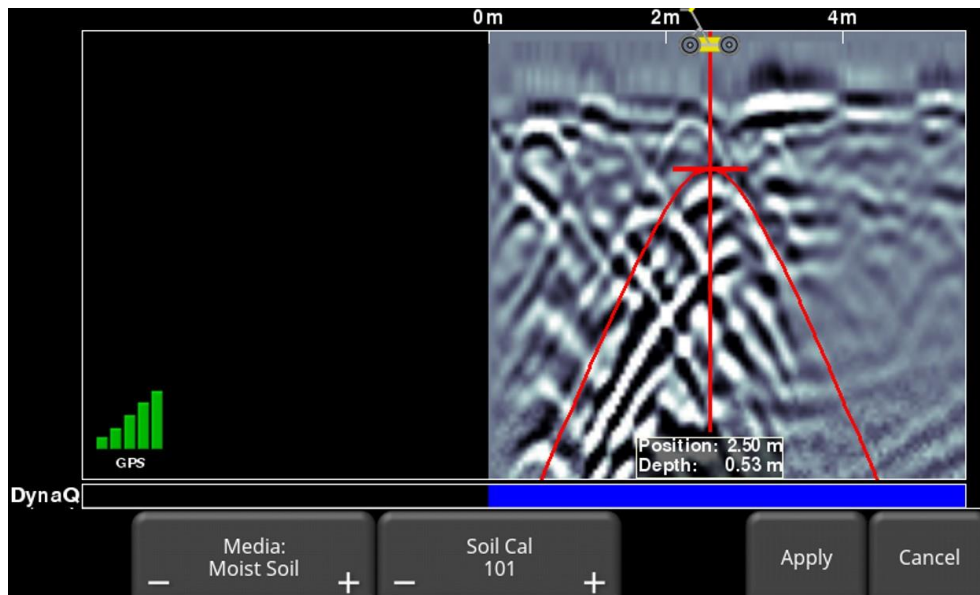

Figure 6-13: Adjusting Soil Cal while in backup mode

On the other hand, if you press Soil Cal while you are collecting data or have pressed Stop, you will see a red hyperbola in the middle of the screen. Drag the hyperbola such that it lies over a real hyperbola from the ground (Figure 6-15). You can use the 4-way keypad arrows to fine tune the movements.

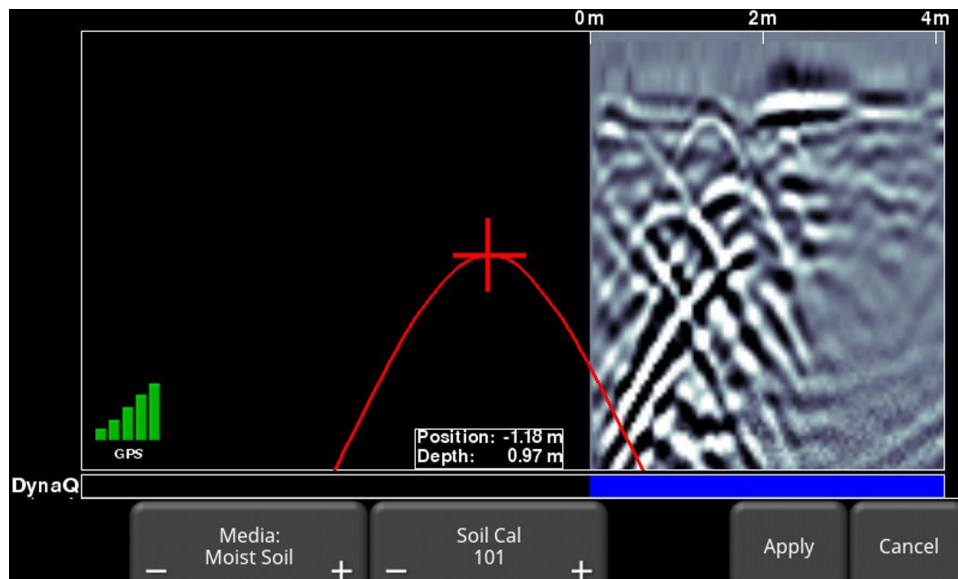

Figure 6-14: Adjusting Soil Cal while stopped

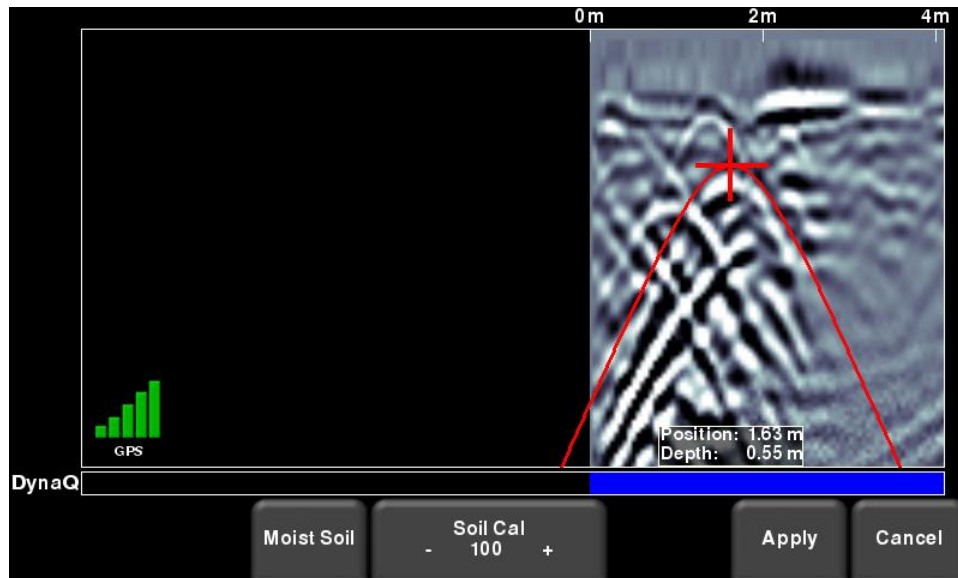

Figure 6-15: Adjusting Soil Cal, without backing up

For either scenario above, once the red hyperbola is properly positioned, you can now use the **+** and **-** buttons on the **Soil Cal** button to widen or tighten the shape. Once the shape is matched (Figure 6-13 and bottom image of Figure 6-15), you now have the correct Soil Cal and the measured depths will be most accurate. Press **Apply** to use this value.

If you get a Soil Cal near 300, this could be an Air Wave ([Section 5.5](#)), and you should calibrate to a different hyperbolic response.

6.6.6 Interp

Short for field interpretation, Interps are used to mark subsurface features. Seven colours are available, which allow you to designate different types of subsurface objects.

Either during collection, back-up or review, you can simply touch anywhere on the screen to add an Interpretation (Figure 6-16). This appears as a dot of whatever colour is selected. To change the color, press the **Interp** button to see a selection of colours and to select a new one (Figure 6-17).

To remove an Interp, ensure the same color is currently active and simply touch the Interp to delete it.

These field interpretations get exported with the data as a .CSV file, which show the positional information of all interps. They can be used to check if a feature is linear (in Map View or in Google Earth™), but only if the more accurate external GPS is used.

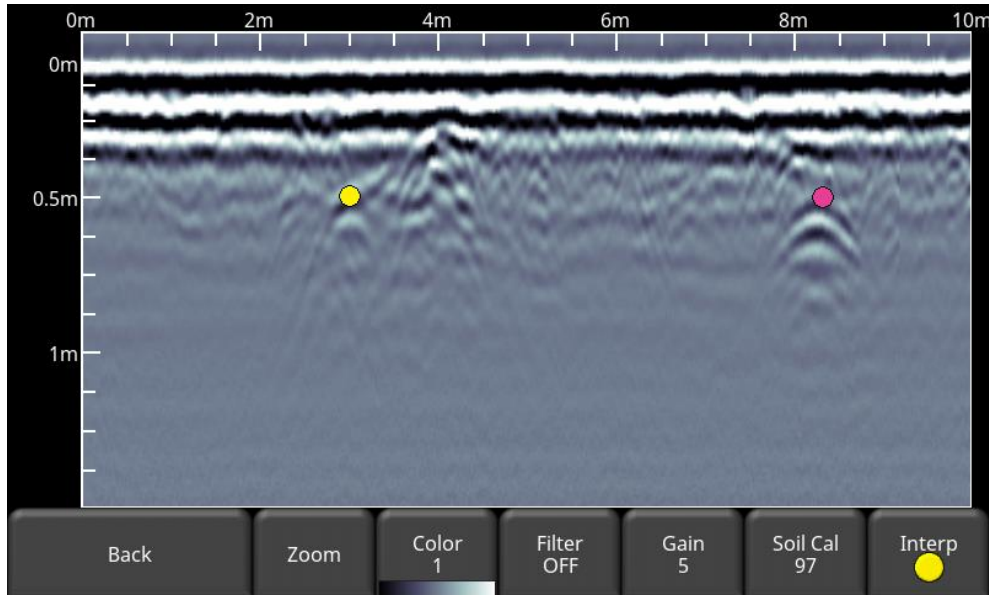

Figure 6-16: Touching the screen to put Interps

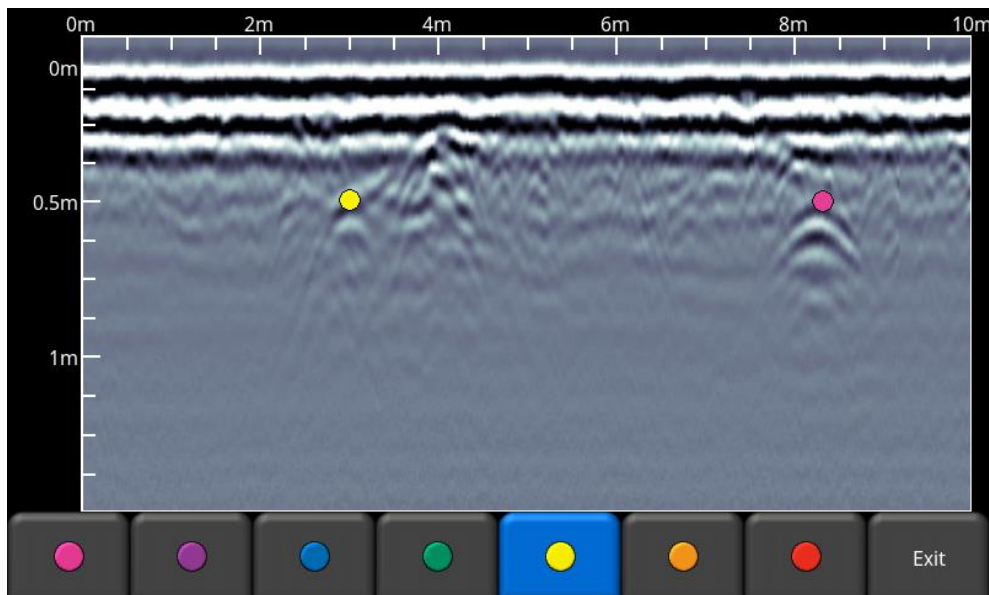

Figure 6-17: Available colors for Interps

6.6.7 No Save Mode

No Save Mode allows you to collect Line Scan data without saving it. All other options available in regular Line Scan mode are available, with the exception of Interps.

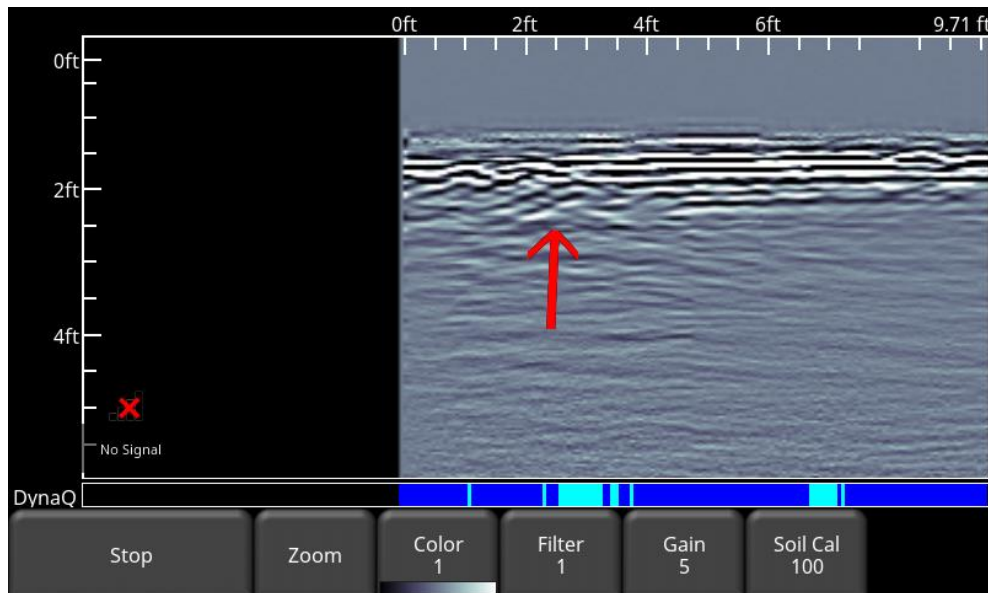

Figure 6-18: Drawing arrows on the screen to highlight targets and features

The user also has the ability to draw arrows on the screen (Figure 6-18). Touch the screen where you want the head of the arrow to appear, and then swipe away in the direction of the shaft. Any number of arrows can be drawn on this screen. Touch any arrow to remove it.

Remember that pressing the Camera button will take a screenshot and save it in the currently selected project.

7 Grid Scan

Grid scans are conducted to generate depth slices over a given area. This is useful for locating all known and unknown objects, as well as their orientation, in a graphical manner that is easy to interpret.

From the main menu (Figure 3-2), press the **Grid Scan** button to enter the Grid setup menu.

7.1 Grid Parameters

The screen in Figure 7-1 will allow you to set parameters of the grid, before data acquisition begins.

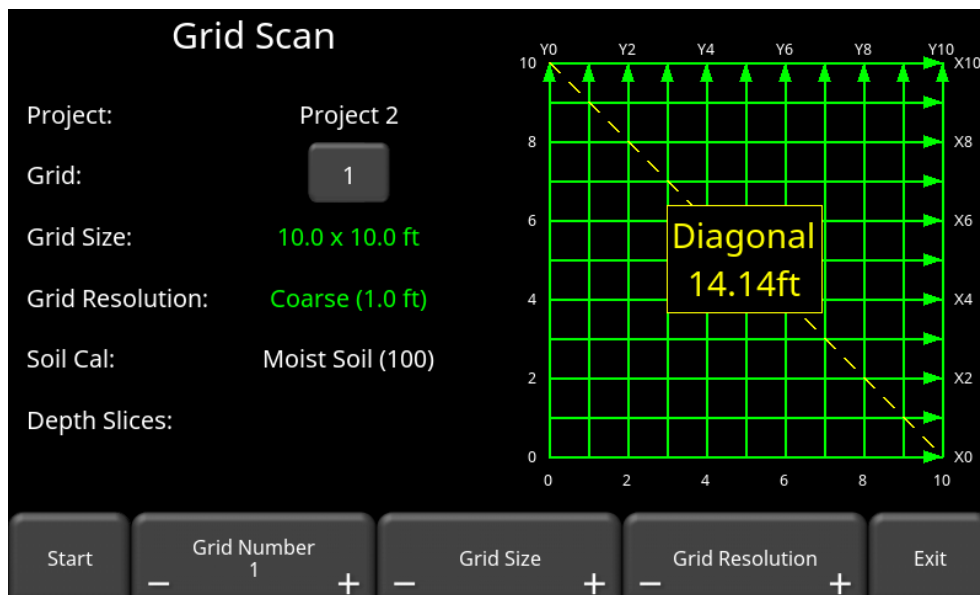

Figure 7-1: Grid Scan setup

7.1.1 Grid Number

To select a grid number, press the **+** and **-** buttons under **Grid Number** at the bottom of the screen. Alternatively, pressing the grid number button itself will show the screen in Figure 7-2. From here, you can go directly to any grid. Grids that contain no data will have some text and grid lines shown in green, whereas grids containing data will have the text and grid lines shown in red. Grids that are partially complete will show the uncollected lines in green on the right side.

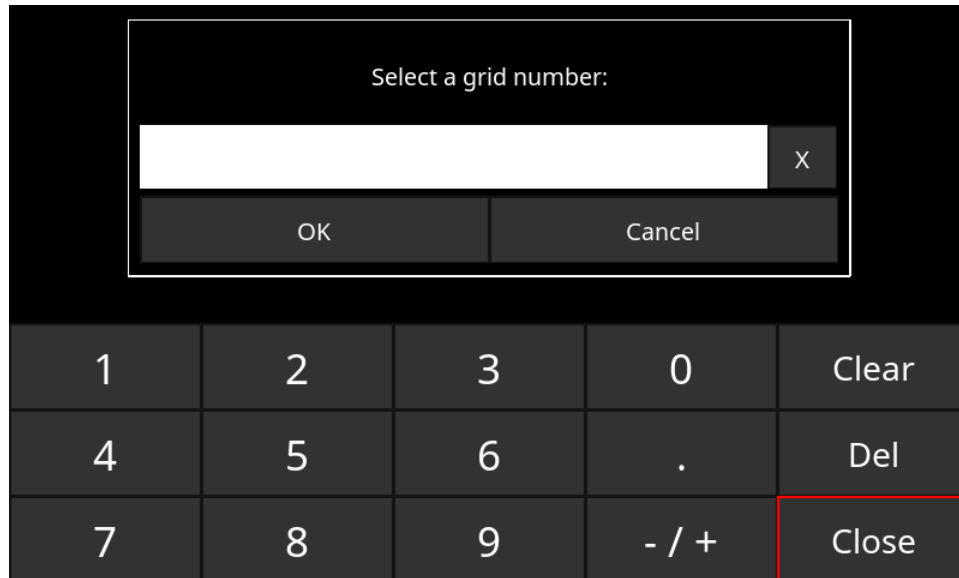

Figure 7-2: When the button showing the grid number is pressed, this screen allows the user to directly input the grid they wish to go to

If a grid already contains some data, it will be shown in red and you will not be able to change the size or resolution. You will just have the option to select:

- **Slice View** – view the depth slices (provided at least 3 lines are collected)
- **Delete Grid** – delete all the data in this grid

You can press Start to enter a previously collected grid, either to view data or recollect a line.

Make sure the units are the same, or else a warning message will display when you try and collect a line (Figure 7-3). You cannot continue in collecting that grid until you make the units the same.

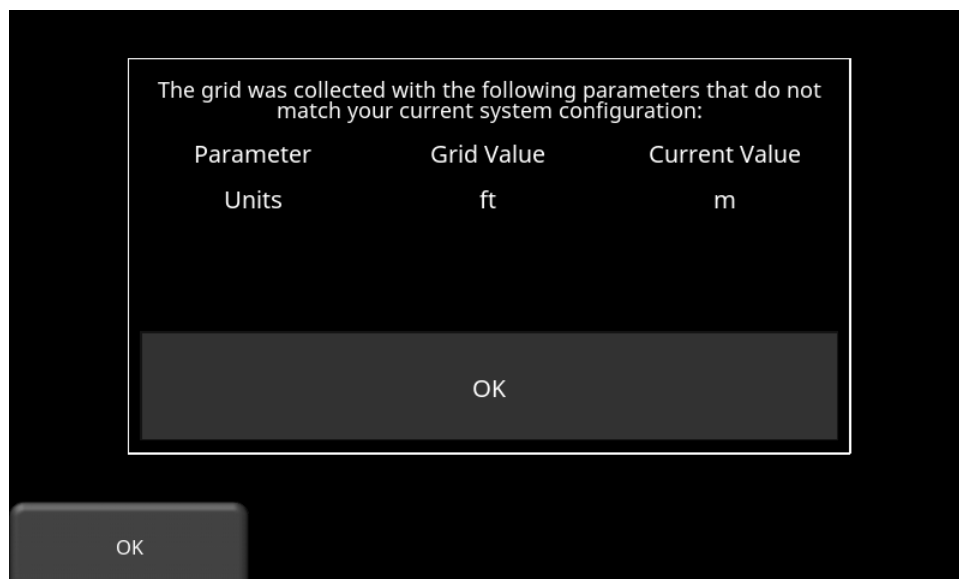

Figure 7-3: Warning message when units do not match

7.1.2 Grid Size

Press the + and - buttons under **Grid Size** at the bottom of the screen to change the dimensions of the grid. Alternatively, you can press the + and - buttons on the screen beside **Grid Size** on the upper part of the screen.

In metric units, the available grid sizes are 3m x 3m, 5m x 5m, 10m x 10m and 15m x 15m.

In US standard units, the available grid sizes are 10ft x 10ft, 20ft x 20ft, 30ft x 30ft, 40ft x 40ft,

7.1.3 Grid Resolution

Grid resolution determines the spacing between grid lines. This can be varied by pressing the + and - buttons under **Grid Resolution** at the bottom of the screen. Alternatively, you can press the + and - buttons on the screen beside **Grid Resolution** on the upper part of the screen.

Available options are 0.1m, 0.2m, 0.25m, 0.5m in metric units and 4 inches, 6 inches, 1.0ft, 2.0 ft in US standard units. The best images will result when the finest grid resolution value is used.

Note that due to size processing limitations, the largest grid size will not work with the finest resolution. A message will be displayed as shown in Figure 7-4, and you will not be able to enter the grid.

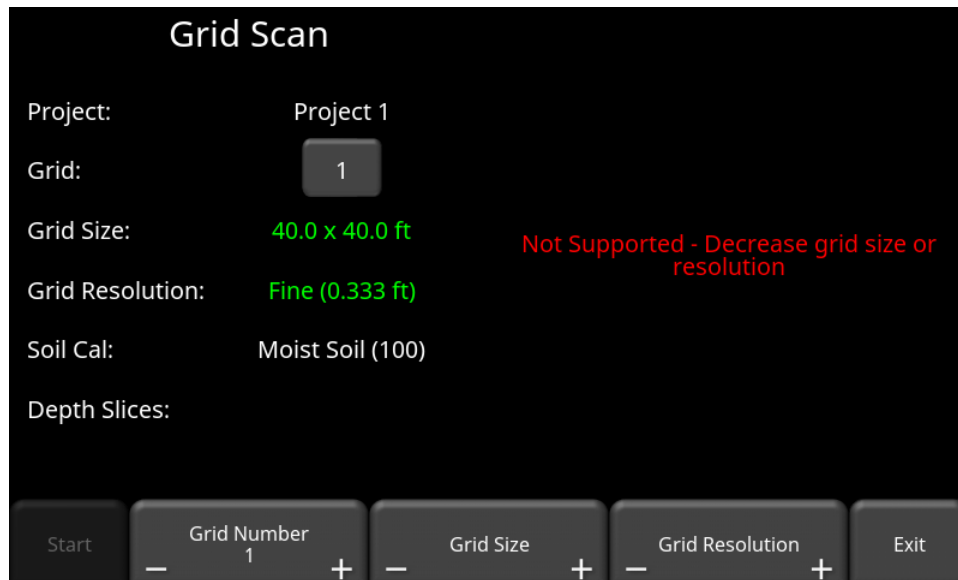

Figure 7-4: Message indicating grid size and resolution are not compatible

Calculating Resolution

The size of target will determine line spacing. The system must pass over a target to detect it; line spacing needs to be on the order of the size of the target or smaller when practical. This can be adjusted to a larger spacing for larger targets or targets that are linear. As well, these rules may have to be bent for practical purposes such as survey production rates. Tighter line spacing takes longer to collect and may not be economically possible in all circumstances.

7.1.4 Starting data collection

Press **Start** when all the parameters are setup and data collection is ready to begin.

7.2 Laying out the grid

Positional accuracy of each line is vital to locating targets of interest once data has been processed. Follow the steps below to layout the grid.

Step 1 – Define the axis- Lines parallel to the Y-Axis are called Y-Lines. Similarly, lines parallel to the X-Axis are called X-Lines (Figure 7-5). Pick the origin of the grid such that it is the furthest corner away from any obstacles. This way, all the lines start properly, but they can be ended early if there is an obstruction.

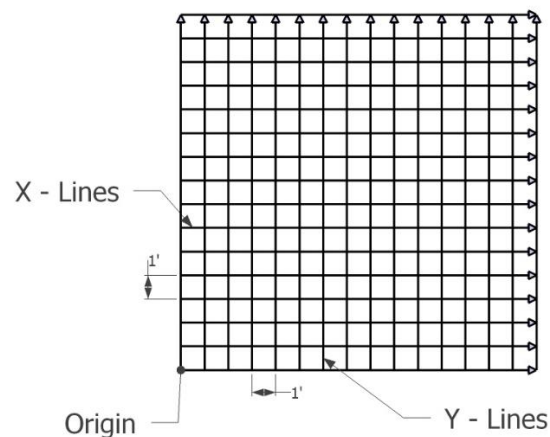

Figure 7-5: X-Lines and Y-Lines relative to the Origin.

Step 2 – Layout the Grid – for maximum accuracy, it's very important to establish a right-angle triangle (Figure 7-6). The easiest way is to use a single tape measure and refer to the diagram below. Start at the origin, walk out the desired distance for x-axis (A) and mark that point. Then then turn 90 degrees and walk out the desired distance for the y-axis (B) and mark that point. Determine the hypotenuse side (C) from the screen (Figure 7-1), then close in the triangle (C - hypotenuse side) back to the origin, making sure you meet the origin at the distance for C. If not, move that last point in tandem with the origin, such that both sides of the tape measure are taut.

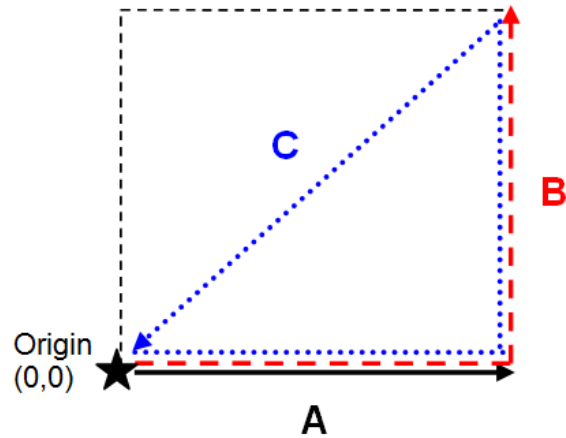

Figure 7-6: Forming a right-angle triangle

Step 3 – Mark the Line Start Positions – with the tape measure still on the ground, mark the line start positions based on the line spacings (Figure 7-7). Usually flags or paint work for grass, and chalk or paint on concrete. It is also recommended to paint a distance measurement every so often, in case you forget which line you're on.

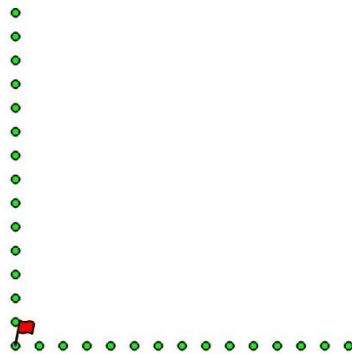

Figure 7-7: Marking the starting positions for every line

Step 4 – Mark the End Positions – if you are doing a forward only grid, it is recommended to mark the end positions (Figure 7-8). You will need to aim for something to make sure your line is straight. The end positions don't have to be the exact length of the line (as the GPR will stop when the set distance is reached), but just something to aim for.

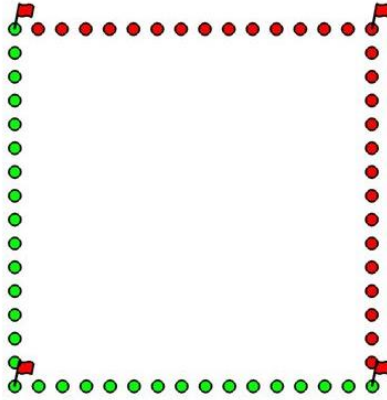

Figure 7-8: Marking ending positions

An example grid layout is shown in Figure 7-9.



Figure 7-9: Example of a grid survey. The red lines are superimposed just to illustrate the concept.

7.3 Data Collection

7.3.1 Physical Data collection

It is critical that the starting position is consistent on every line. Line up the middle of the unit with the starting line, and then push the system straight towards the end of the line. It is helpful to have a marker at the end so you have something to aim for.

Not all lines have to be finished. If there is an obstruction preventing you from finishing the line, you can simply press Stop and end the line early. Do not try to steer the system around the obstruction, as this will throw off the positioning of the data.

In addition, not all lines have to be collected. If your area of interest is only 4m x 4m, set the Grid Size to 5m x 5m, but just don't collect the outer lines.

7.3.2 Data collection on the Display Unit

The data collection screen is shown in Figure 7-10. The right half of the screen is a graphic representation of the grid, illustrating the size of the grid and the lines that need to be collected. The left half of the screen will display the last grid line collected.

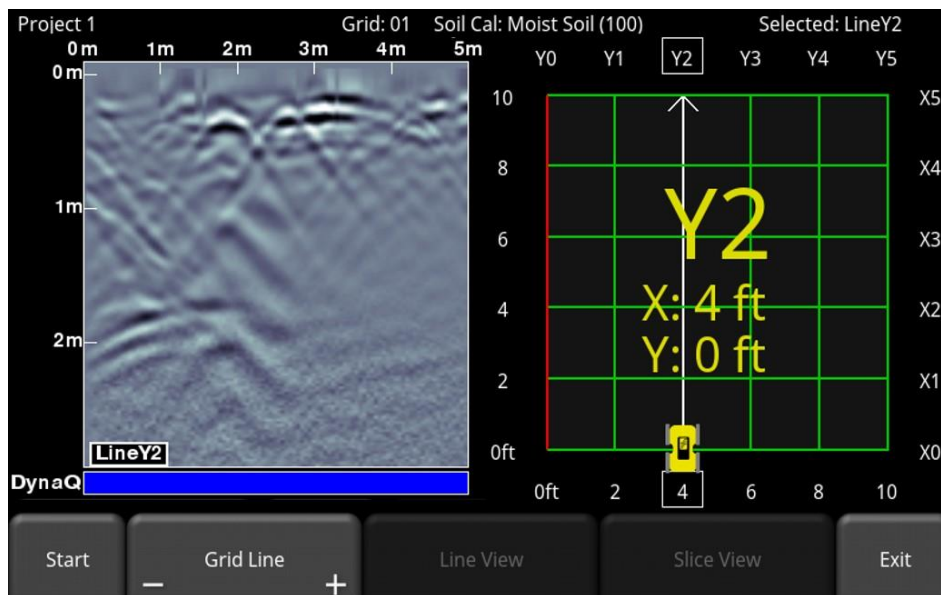

Figure 7-10: Grid collection screen prior to any data collection

Press **Start** when you are positioned at the start of the line. Push the system in a straight line towards the end of the line. The system knows the length of each line and will automatically stop acquisition once that distance has been covered. If the data acquisition ends prior to reaching the end of the line, or continues noticeably past it, you likely need to do an Odometer Calibration ([Section 4.2.6](#)).

Once data is collected, the Grid Line will turn red and the system will beep twice. The current line will now advance to the next one and is shown in white. The remaining lines to be collected are shown in green.

Move to the start of the next line and repeat the process. The grid image will always display the line number and the position of your line, relative to your origin. Once all the lines are done in one direction, it will automatically prompt you to collect lines in the other direction.

Note: Periodically ensure that the line you are collecting matches what is displayed on the screen. This is especially important as the grid sizes get larger and you may misplace your position.

7.3.3 Collecting around an obstruction

From time to time, there may be an obstruction (such as a tree or rock) in your survey area. There is a temptation to pick up the system, move it around the obstruction and continue collecting. This is wrong!

The correct way is to approach the obstruction from both directions. Granted there will not be data where the obstruction is, but there will be data before and after it.

When you approach the obstruction, terminate the line by pressing **End Line**. The system will advance you to the next line, but if you cycle back to the line using the **4 way** directional keypad, it will return to the same line, but in the reverse direction. The name of the line will now contain an R at the end. Sometimes people prefer to collect all the lines in one direction, then collect all the reverse lines on the other side of the obstruction.

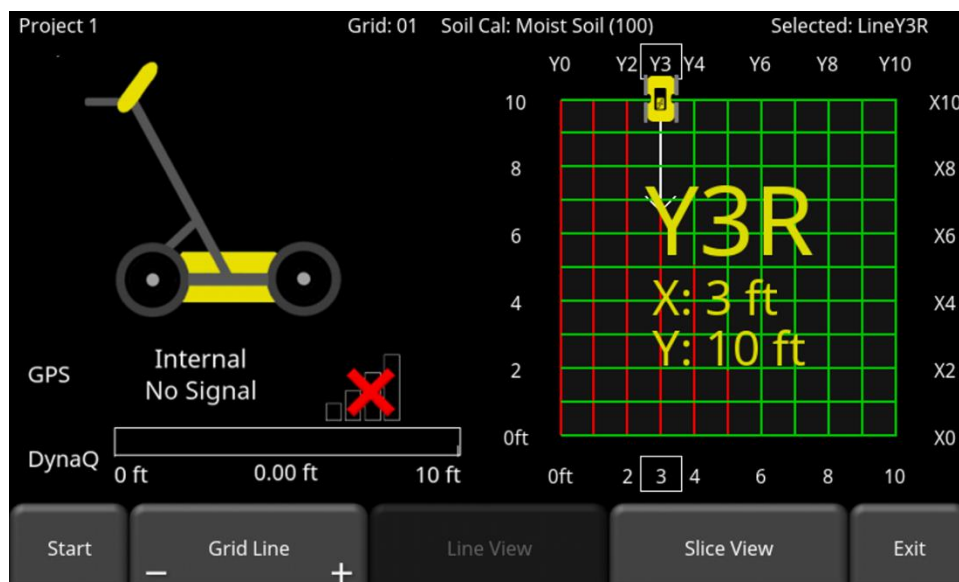

Figure 7-11: Collecting a reverse line

In the example in, Line Y3 was partially collected due to an obstruction. To collect from the other direction, the left arrow button was pressed on the 4-way directional keypad to return to that same line, but now the line is drawn from the other direction. This new line will now be labelled Y3R.

7.3.4 Line View

To display the currently selected grid line on the full screen, press the **Line View** button (Figure 7-12). In this view, you have the option of modifying the image by changing the Zoom, Color, Filter, Gain and Soil Cal values. It is also possible to display other collected grid lines using the keypad arrow buttons.

To exit from the Line View screen and return to Grid View, press the **Back** button. The Grid View screen respects any display settings changed while in Line View. If the Soil Cal is changed, the depth slices will be reprocessed.

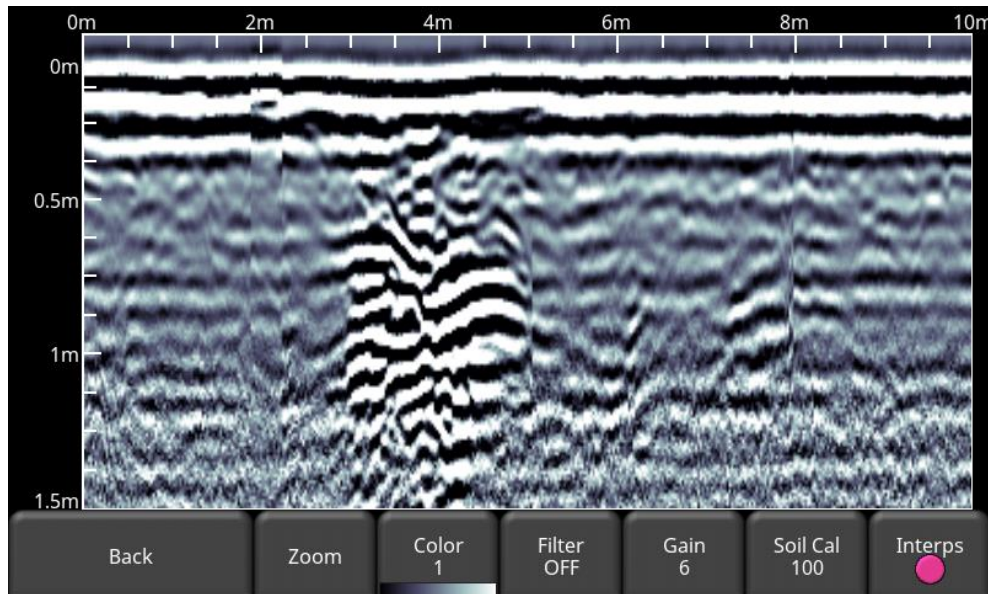

Figure 7-12: Line View screen

7.3.5 Recollecting & skipping lines

You may want to recollect a line if you make a mistake. To move to a different line:

- Press the **+** and **-** buttons under **Grid Line** OR
- Touch any **line** on the grid image on the right OR
- Use the **4-way directional keypad**

Then simply hit **Start**. You will be prompted with a message asking if you want to overwrite that line (Figure 7-13). Press **Yes** to proceed.

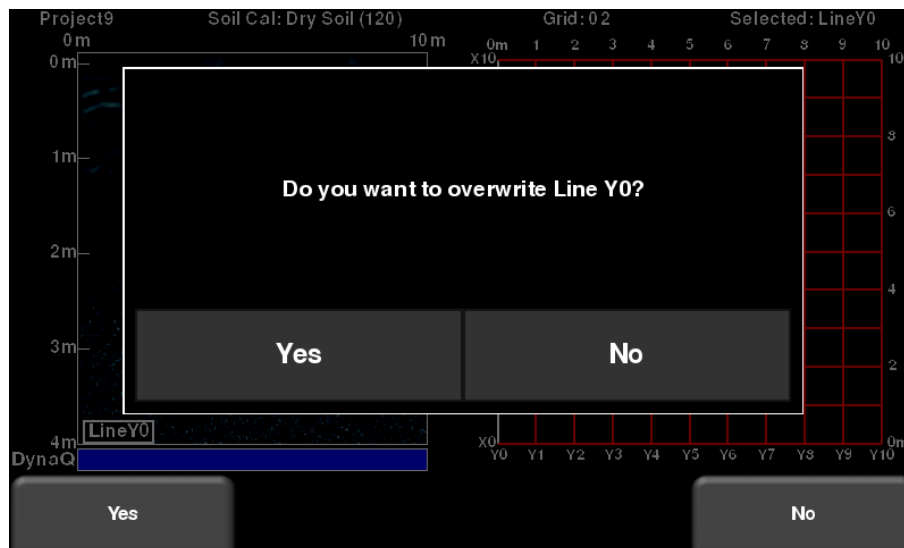

Figure 7-13: Overwriting a line

7.3.6 Processing data

Once you have finished collecting all the data, press **Slice View** at the bottom of the screen. Before the data is processed and depth slices created, you must ensure the Soil Cal is accurate; this will result in the most accurate and sharpest images.

A message will display advising the Soil Cal that will be used (Figure 7-14). If you have adjusted this already for the ground you are on, you can press OK to proceed and create the depth slices.

If not, then it is recommended to press Cancel and adjust the Soil Cal by using a good hyperbola on one of the collected lines. Then return and press Slice View and press OK to proceed and create the depth slices.

See the next section on using Slice View.

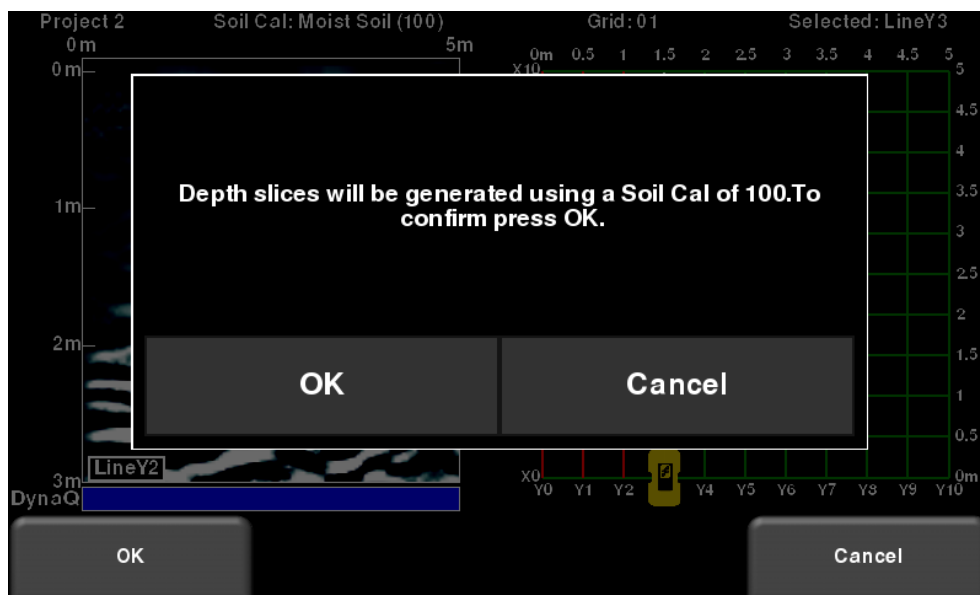

Figure 7-14: Processing with Soil Cal value

8 Slice View

Slice View displays data collected in a grid as a series of depth slices moving deeper into the subsurface. Objects and features appear in plan view, which can be an easier way of visualizing the data.

Upon entering Slice View, the screen will be displayed as shown in Figure 8-1.

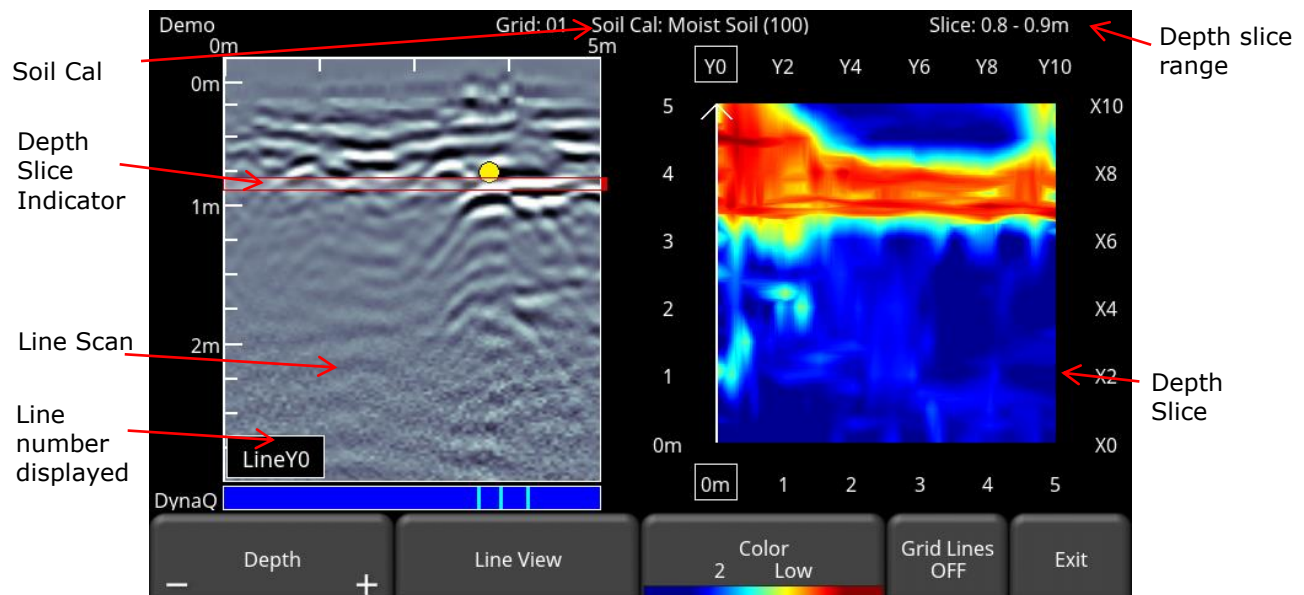

Figure 8-1: Slice View screen

The right half of the screen shows one of the depth slices. These slices are 5cm or 2" thick. The top and right sides of this image show the dimensions of the grid while the left and bottom sides show the line numbers.

The left half of the screen displays one of the grid lines, and any flags or interpretations that were made. The shaded area in between the horizontal red lines corresponds to the depth slice shown on the right. To move to another grid line, use the 4-way directional keypad on the Display Unit.

At the top of the screen, the grid number is listed, along with the Soil Cal value and slice thickness range.

The button functionality is explained below:

8.1 Depth

Pressing the + and - buttons on the **Depth** button will increase or decrease the depth of the depth slice currently displayed. You can also drag the depth slice indicator on the line scan image. This allows the user to "slice through" the ground and locate features that appear at different depths.

8.2 Line View

Pressing this button displays the currently selected GPR line as a full screen image. All the functionality of Line Scan (such as Depth, Color, Filter, Gain, Soil Cal, Interps) are available here (Figure 8-2). Use the **4-way directional keypad** to change to a different line.

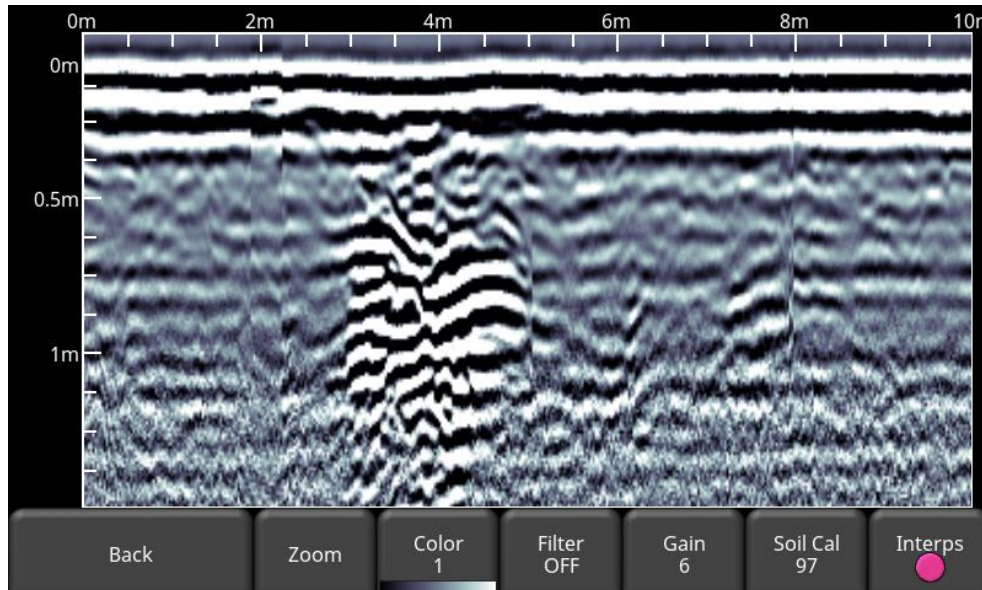

Figure 8-2: Changing Line View settings from within Slice View.

Press **Back** to return to Slice View. Any changes made will be reflected on the GPR line in Slice View mode. If you change the Soil Cal or Zoom (depth), this will cause the depth slices to be re-processed.

Users may want to change these display settings to make it easier to correlate line scan data with depth slices.

8.3 Color

This heading has two button functions beneath it:

- Color Palette** - The number corresponds to the color palette used for the depth slice image. Pressing this button cycles between the 9 available color palettes available on the system.
- Color Sensitivity** - cycles between **LOW**, **MEDIUM** and **HIGH**. A setting of HIGH is useful for revealing weaker targets which can sometimes be difficult to see. Setting to LOW will help “clean up” the data and only show the strong targets, but will hide some of the weak signals so be careful when setting to LOW. Figure 8-3 shows the variations in color sensitivity.

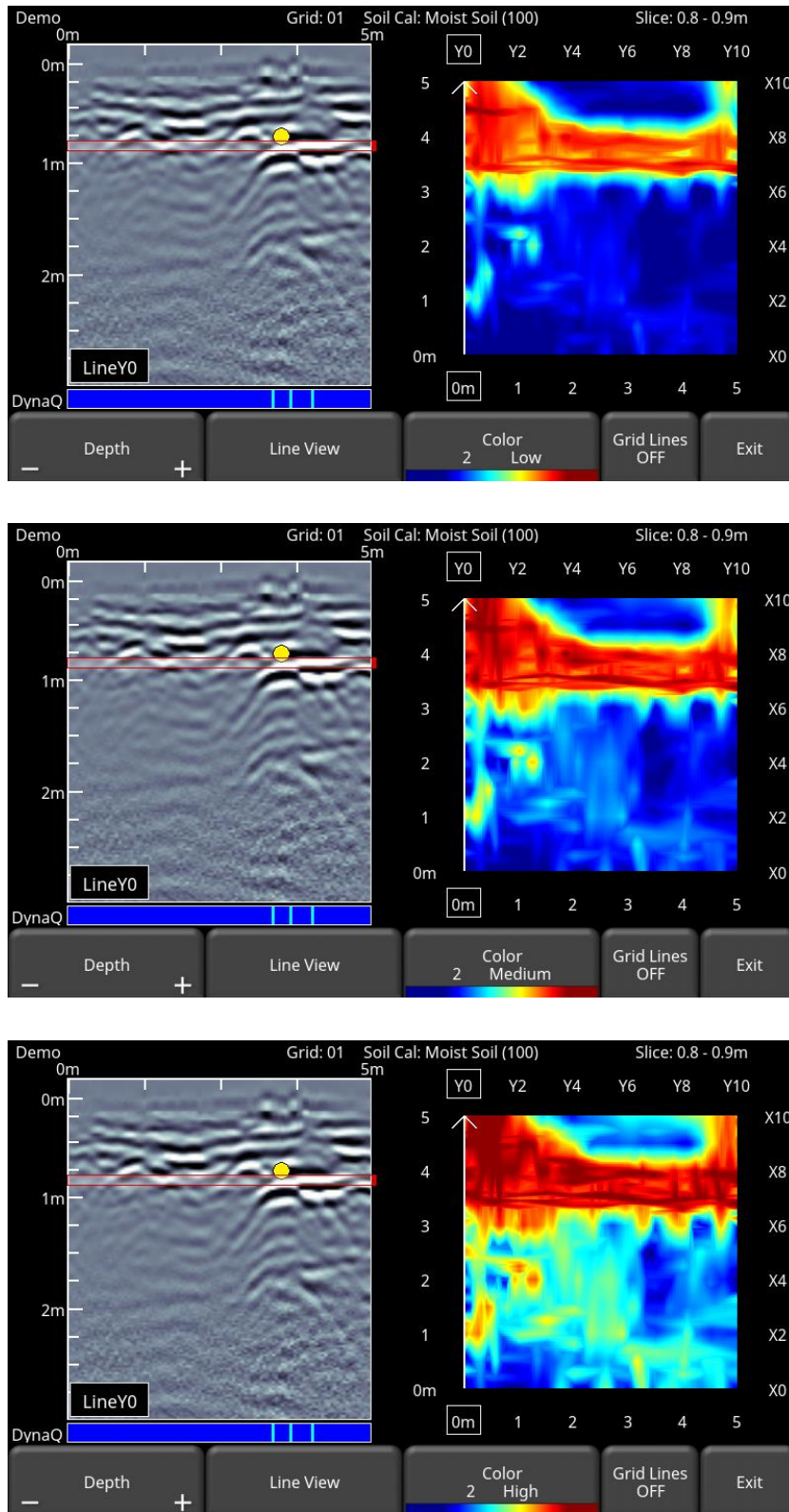
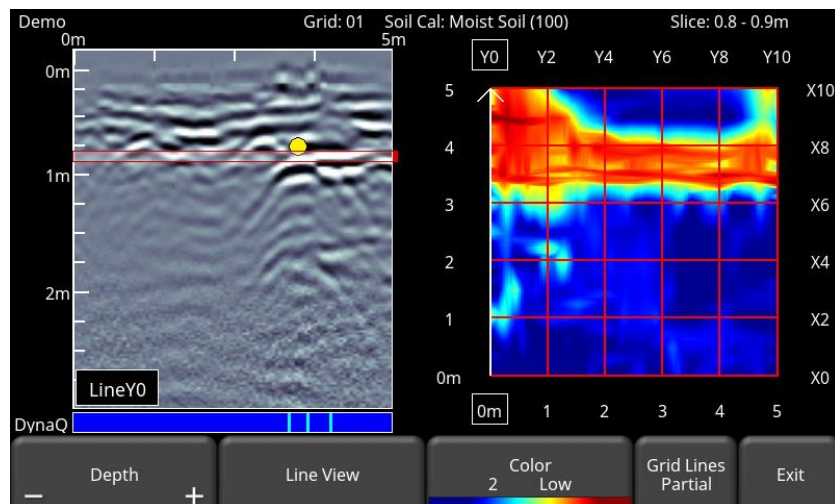
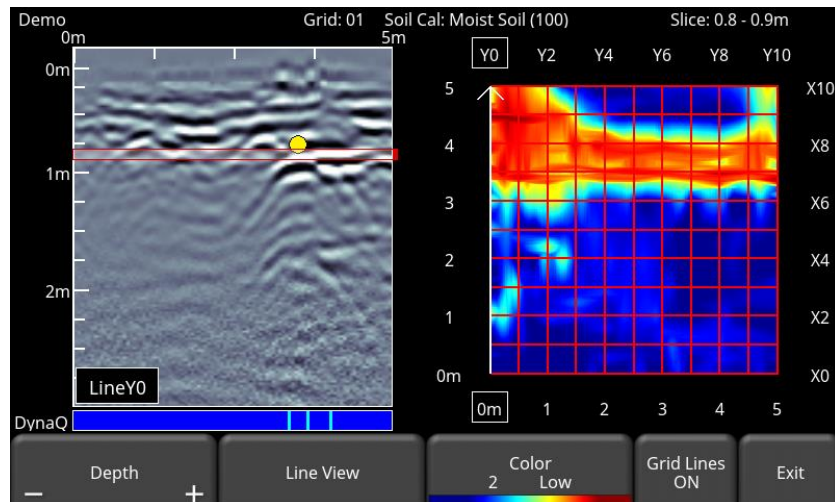

Figure 8-3: Varying the sensitivity, from top to bottom: Low, Medium and High settings. High shows more subtle targets but may sometimes appear cluttered while the Low setting only displays the strongest targets so be cautious when using it.

8.4 Grid Lines

Pressing this button overlays grid lines on the depth slice image, and cycles between **ON**, **PARTIAL** or **OFF**. When set to ON, all the collected lines are displayed. When set to PARTIAL, only some of the grid lines are displayed. This may be necessary for some larger grids as having all the grid lines ON tends to obscure the image beneath (Figure 8-4). The currently selected line is always shown in white.



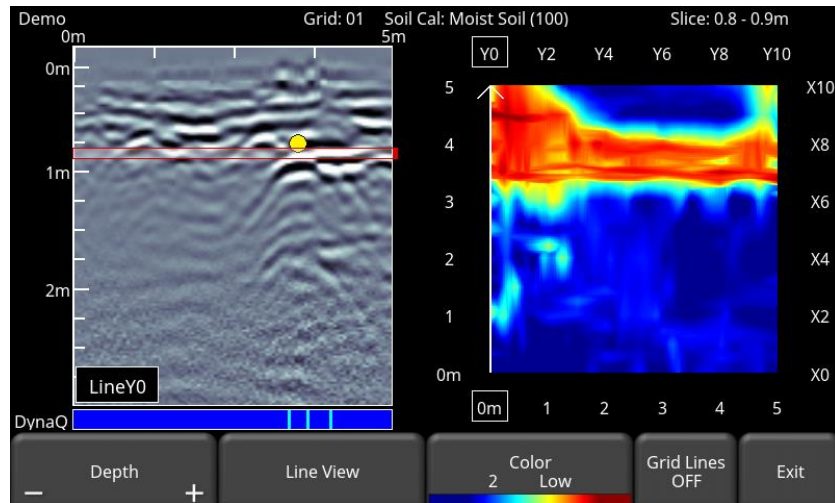

Figure 8-4: Varying the Grid Lines, from top to bottom: ON, PARTIAL and OFF settings.

8.5 Recollecting lines

After looking at the grid data in Slice View you may discover that one or more grid lines need to be recollected (for example, maybe the starting position was offset). If so, you will need to enter the Grid Scan menu again and select the appropriate grid number and press Start (the grid number will be in red, since data exists).

Select the grid line that needs to be recollected. When you press **Start**, it will display a prompt confirming if you want to overwrite the line. After recollecting the grid line(s), press the **Slice View** button to re-process the grid data.

9 Map View

Map View is a unique feature that allows the user to graphically view the path travelled by the system, and any flags or interpretations made. It will also display a view showing the lines collected as part of a grid.

A common use of this feature is to snake back and forth over a given area. Each time you cross a target, click on the top of the hyperbola to add an interpretation. If the object is a linear feature, all the interpretations will line up when viewed in Map View.

Map View only works if GPS data is collected with the GPR data. This is what allows the lines and/or grids to be positioned correctly (with the right orientation).

If you use the internal GPS, only grid data will be shown in Map View. If an external GPS is connected, both line and grid data will be shown.

9.1 Accessing Map View

Map View can be accessed from the main screen or from the File Management menu (Figure 9-1). Map View is *project* based, meaning it will display all lines and grids that are present in a given project.

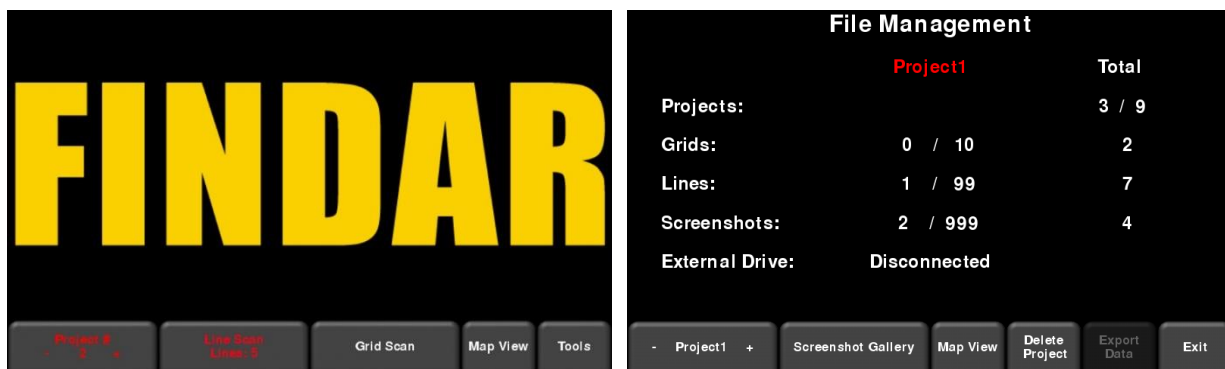

Figure 9-1: Accessing Map View from either from the a) Main screen or b) File Management menu

9.2 Map View screen

Entering **Map View** will show an image similar to the one in Figure 9-2, with the following options which are described below:

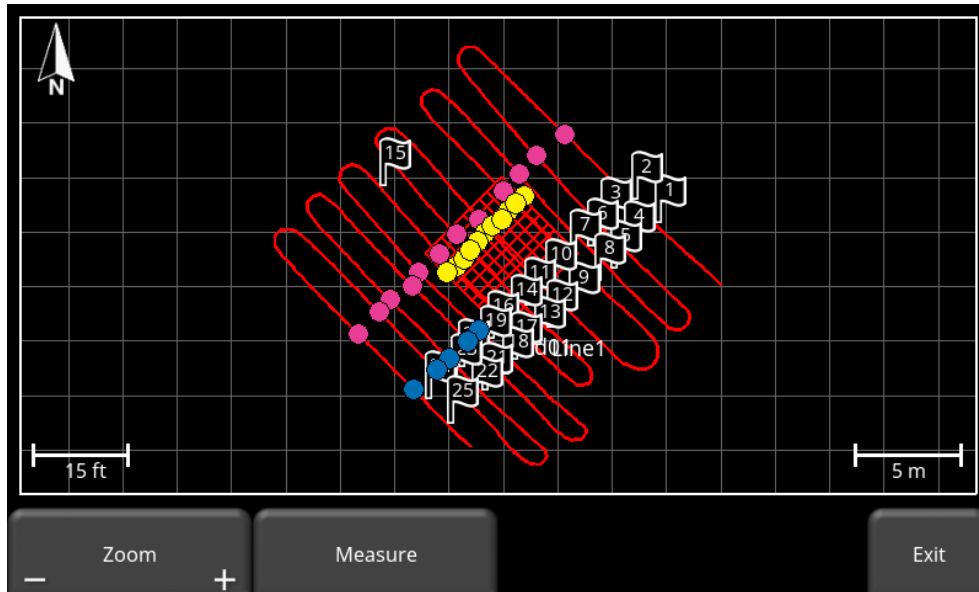

Figure 9-2: Map View showing the position of two grids and one line

- Pressing **Zoom +/-** will zoom accordingly. To reposition the image in the middle of the screen, simply swipe the screen until the image is positioned properly.
- When the **Measure** button is pressed, it is highlighted in blue. During this time, you can touch the screen and drag your finger a certain distance to get a measurement value for that distance. The distance value is displayed in the top right corner (Figure 9-3). Pressing the Measure button again exits from Measure mode and removes the yellow measured line and the measured value.

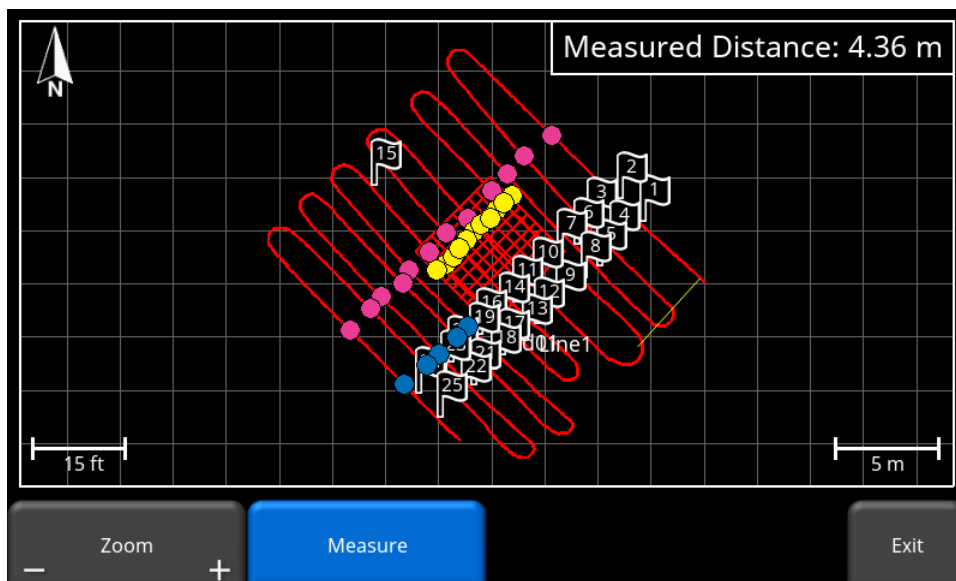

Figure 9-3: Using the Measure tool to draw a line on the screen

10 Demonstration Data

Demo Data is pre-loaded on all LMX150™ FINDAR® systems, and is found in the Demo project folder (from the main screen, press the minus button when you are in Project 1). The Demo project contains 3 lines and 2 grids, and is used to illustrate various application examples.

From a learning point of view, it is recommended go through each line and see the affect of changing display parameters (zoom, depth, calibrating velocity). For the grids, it is useful to move down through all the depth slices to see how features come into focus, then disappear. As well, correlating hyperbolas on the line scans and seeing how they appear on the depth slice images helps to build confidence in what you are seeing.

The following is a brief description of each of the lines and grids:

Line 1:

This data shows buried objects, indicated by strong hyperbolic responses, at positions 8.2m and 10.5m. There is also a zone of multiple objects and disturbed soil from 2.5m to 4.4m.

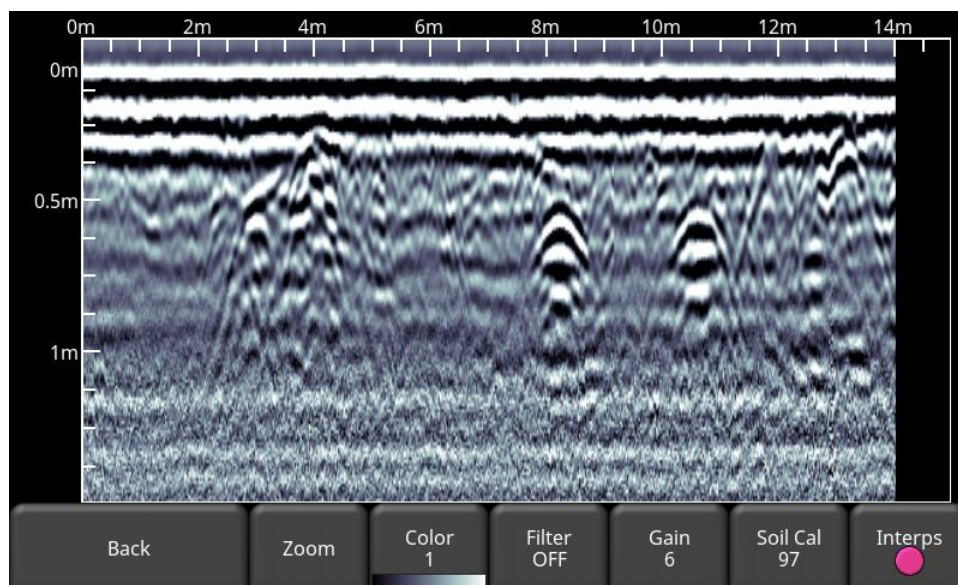

Line 2:

This data shows an area of disturbed soil stretching from position 3m to 5m. The disturbed area shows GPR reflections that are stronger and more chaotic than the surrounding soil, indicating that something is likely buried there.

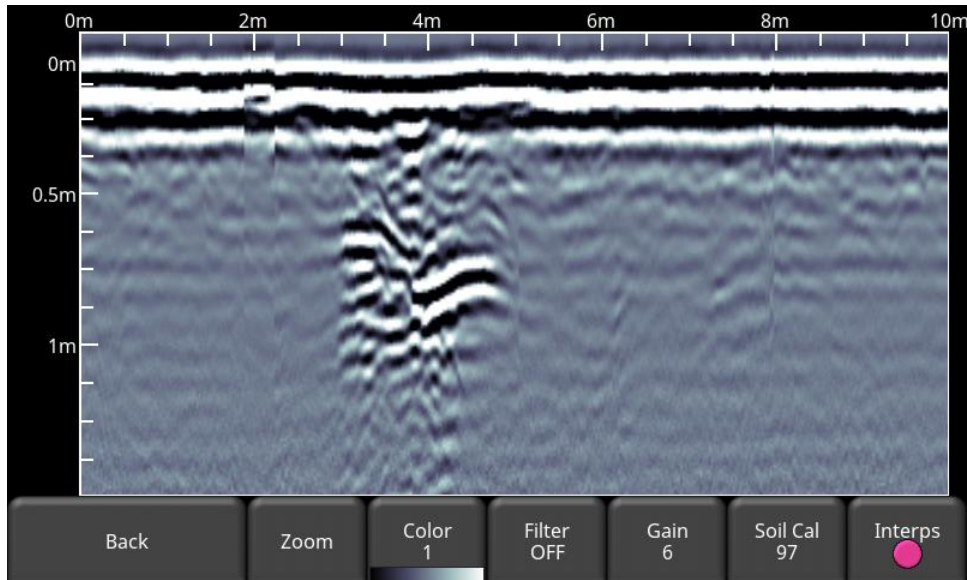

Line 3:

This Line Scan shows a metal object causing a “ringy” response at position 6.6m; two objects, indicated by hyperbolic responses, at 11.0m and 13.4m; a zone of disturbed soil from 14.8m to 17.2m. There is also a strong, dipping object or boundary from positions 6 to 10 meters.

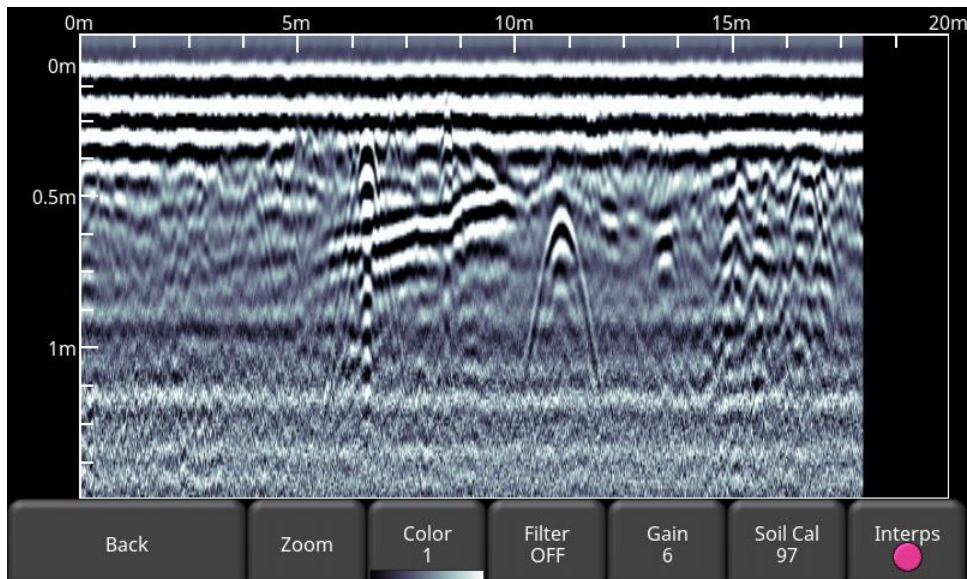

Grid 1:

This Grid Scan shows a 10 x 10-meter grid survey, with collected lines spaced 0.25m apart. The data was collected in one direction only (Y-Lines), as these were graves in a cemetery and the operator knew the direction of the burials based on the grave markers. Depth slicing downward reveals the general shape and varying depth of the coffins, which start to appear at 0.45m deep.

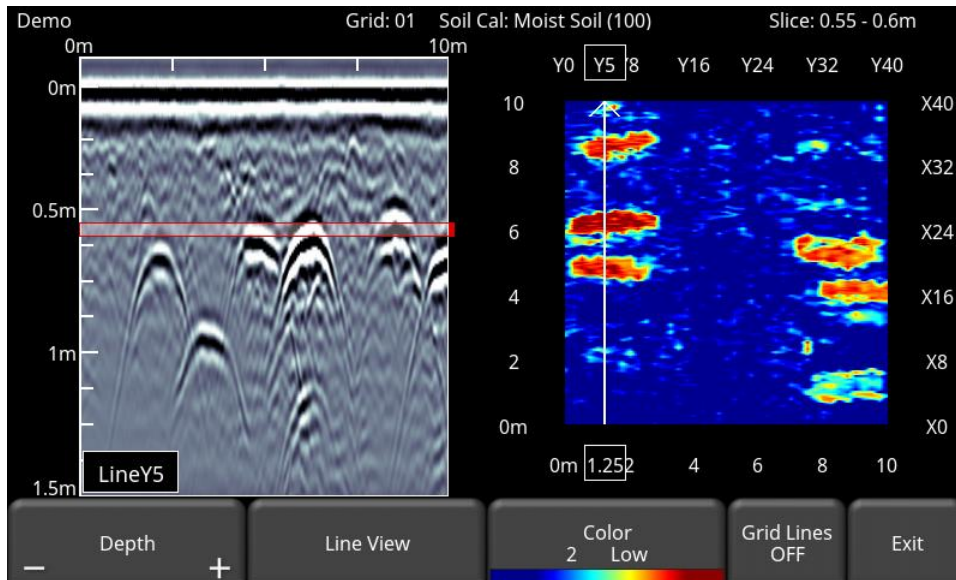

Grid 2:

A 3 x 3-meter grid survey, collected in both directions, with lines spaced 0.25m apart. The grid was collected over a freshly buried pig carcass at a forensic test site. Depth slicing downward reveals the strong response from the body at a depth of about 1.0m.

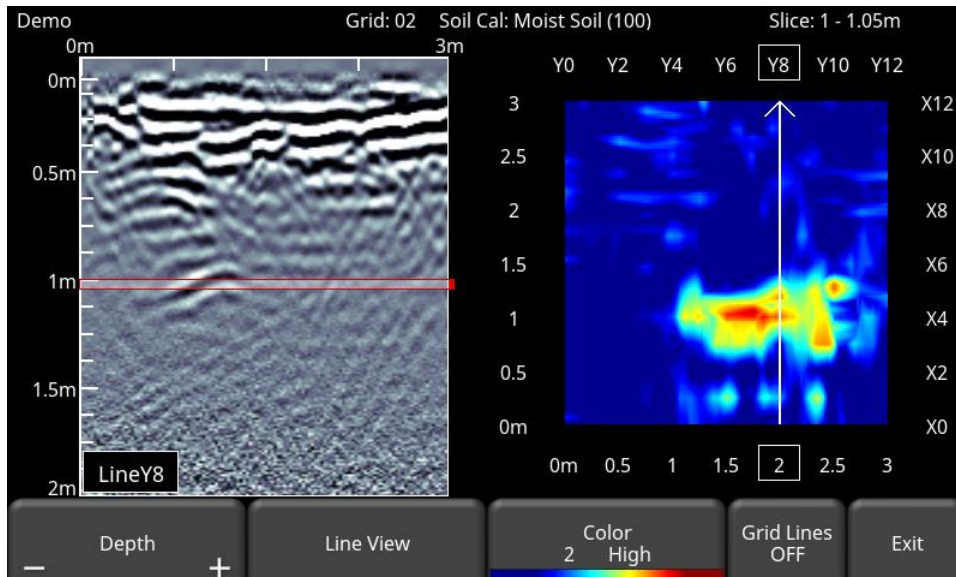

11 Capturing Screens & E-mailing Mini-Reports

11.1 Capturing Screens

If you would like to save an image of the current screen in Line Scan, Grid Scan, Slice View or Map View, press the **Camera** button on the Display Unit. This saves the screen as a Screenshot image (.JPG), which can be viewed in any third-party viewing software. If any GPS is enabled, the screenshot image for depth slices will contain also a geo-tagged reference. However, for geo-tagging line scan images, you must be using an external GPS.

If you are not connected to a Wi-Fi network, a message appears confirming the filename of the saved image (Figure 11-1).

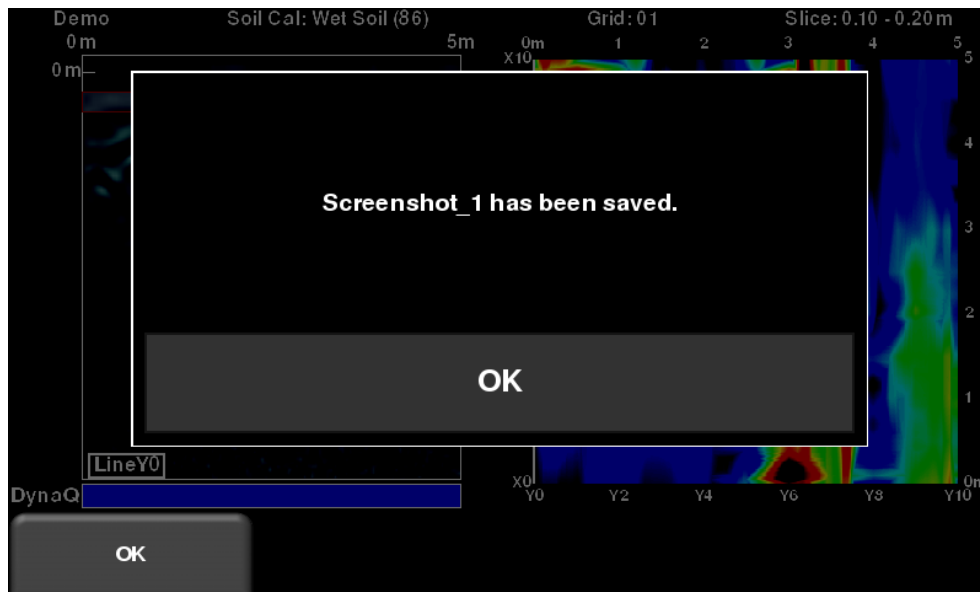

Figure 11-1: Message displayed after pressing the camera button on the Display Unit to capture the screen (no Wi-Fi present).

If you are connected to a wireless network and have a sending e-mail address configured, the user will see the message in Figure 11-2, asking if you would like to email the screenshot and prompts you to enter the email address. The email address defaults to the last one entered. Tapping on the address box brings up an on-screen keyboard and allows you to enter a new email address. Pressing the “...” button to the left of the e-mail address displays the last 5 e-mail addresses used, allowing the user to easily select a recent email, rather than re-entering it. Screenshots can always be e-mailed at a later time from the Screenshot Gallery ([Section 4.3.1](#)).

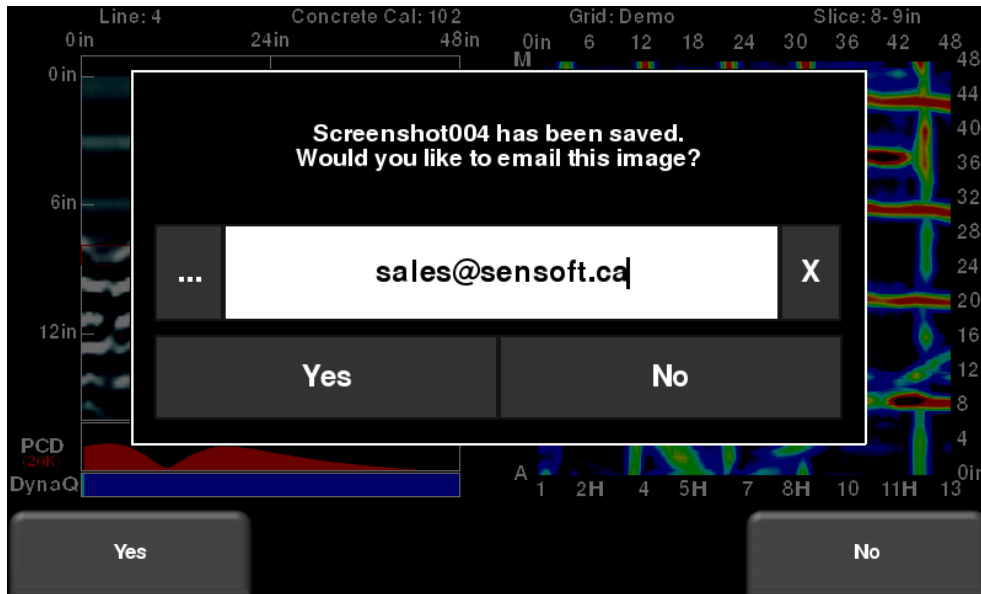

Figure 11-2: Message after pressing the Camera button on the Display Unit to capture the screen with Wi-Fi enabled and a connection to a wireless network. The user can enter an email address to send the mini-report to.

11.2 Using the Hotspot on your Smartphone

If a Wi-Fi signal is unavailable, you may be able to use your Smartphone as a Wi-Fi access point, by creating a Personal Hotspot. If you are experiencing difficulty connecting to a cell phone Personal Hotspot, ensure that the phone is in discovery mode while connecting. On iPhone (iOS 9.0), for example, this involves going to **Settings - Personal Hotspot**. Ensure that the Personal Hotspot setting is turned on and wait on this screen until the LMX200™ connection has been established. Once you have received confirmation on the Display Unit, the cell phone can resume normal use.



Note that when setting up a Personal Hotspot, you may be disconnected from any Wi-Fi networks. Vice-versa, if you have a Personal Hotspot setup, attempting to connect to a Wi-Fi network may disconnect your personal hotspot.

11.3 Mini-Reports

When a screenshot is e-mailed, it is sent as part of a mini-report. This mini-report also contains a table with information about the collected data including the settings used, date & time (Figure 11-3)

FINDAR Mini Report

Project	Demo
Screen Capture Number	2
Screen Name	Line View
Mode	Line Scan - Reflection
Line	1
Depth	1.5 m
Line Color Palette	1
Filter	OFF
Gain Level	4
Soil Cal	Moist Soil (97)
Date Collected	October 11 2018 4:54 PM
Trigger Method	Odometer
Step Size	0.03m
Stacks	DynaQ



Your screen capture is attached to this email.

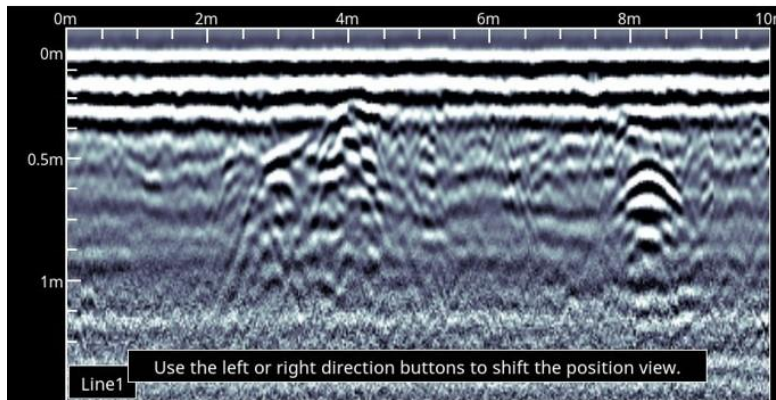

Figure 11-3: Example of a Mini-Report

12 Transferring Data to a PC

Data can be exported to a PC by inserting a USB drive into the USB port (Figure 12-1).



Figure 12-1: Insert a USB memory stick into the USB port on the Display Unit to export data.

Once the USB drive is recognized, a message will appear telling you that a drive has been inserted and if you wish to export your data to it (Figure 12-2). Click **Yes**.

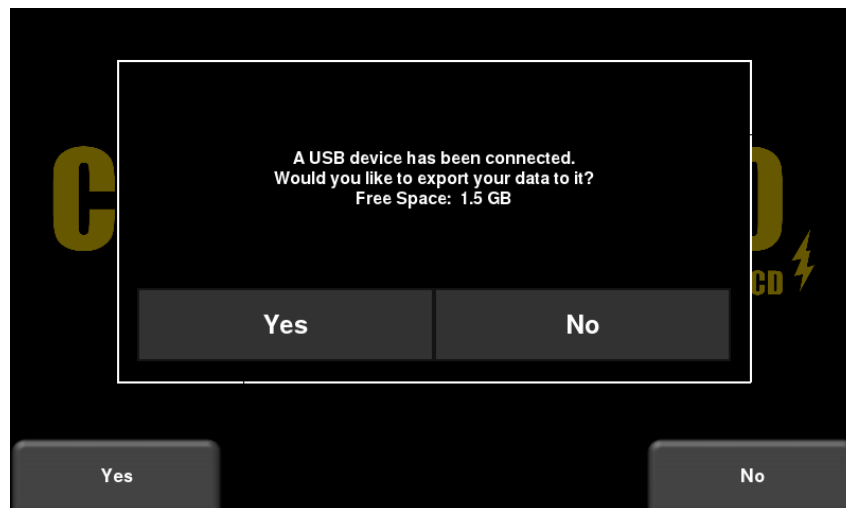

Figure 12-2: When a USB drive is connected to the Display Unit, a message opens asking if you would like to export all your data to it. Select **Yes** to transfer immediately. If you select **No**, you can export the data later by going to the **Setup > File Management** menu option.

If there are grids that were collected, but not processed, it will alert you after you select **Yes** to exporting the data (Figure 12-3). This is important, as unprocessed grids will not automatically

show up in EKKO_Project™ as depth slices (you will need an additional module to view them) – see [Section 12.3](#).

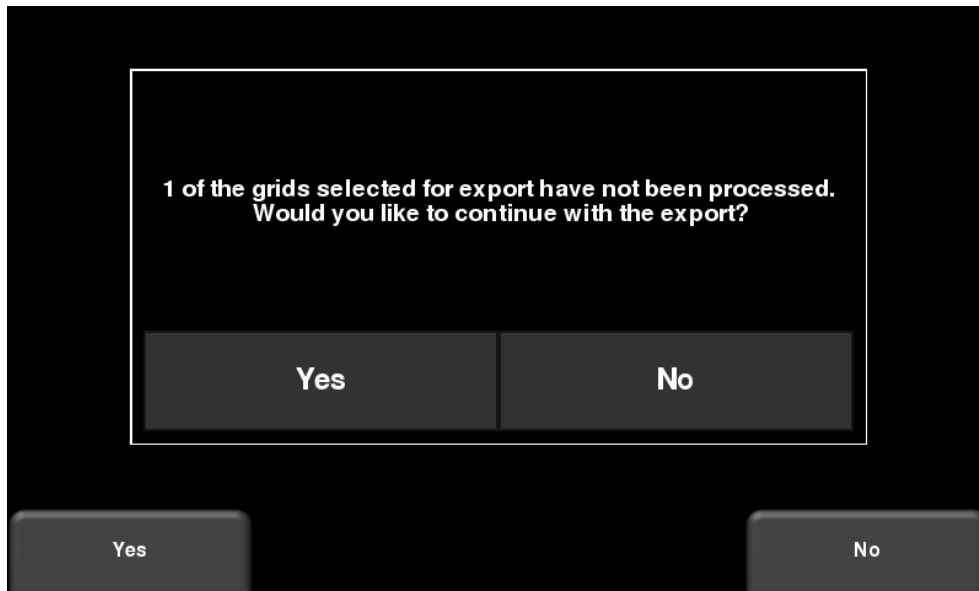

Figure 12-3: Insert a USB memory stick into the USB port on the Display Unit to export data.

Alternatively, if you want to export the data later, you can select No for the time being. Later on, when you are ready to export your data, from the main menu select **Setup > File Management** and press **Export Data** ([Section 4.3.4](#))

12.1 Formatting USB Sticks

There may be times when a USB stick is not recognized by the LMX200™. In this case, you may need to format the USB stick. Ensure that it's formatted as FAT/FAT32 (NTFS will not work). Also ensure that there are no hidden or write-protected partitions on the USB drive.

If the problem persists after formatting, try another USB stick.

12.2 Directory Structure

The directory structure on the USB drive can be viewed on your PC, and will look as follows:

- GPR Data
 - FINDAR
 - Export01
 - Project1
 - Screen Shots
 - All Screenshots as .JPG files
 - Project1.GPZ file
 - Project1.KMZ file
 - Field Interp Report.CSV
 - Project2
 - Screen Shots
 - All Screenshots as .JPG files
 - Project2.GPZ file
 - Project2.KMZ file
 - Field Interp Report.CSV
 - System Info
 - Exportxx
 - Projectx
 - Screen Shots
 - All Screenshots as .JPG files
 - .GPZ file
 - .KMZ file
 - Field Interp Report.CSV
 - System Info

Each successive export of data will create a new directory called ExportXX, where XX is incremented by 1 from the previous directory. The actual GPR data files are all contained in a .GPZ file. This can be opened by the EKKO_Project™ software.

If data was collected with GPS (internal or external), a .KMZ file is also generated. This contains positional information and can easily be opened in Google Earth™.

If any Field Interpretations were added during data collection, these are saved in a .CSV file. This is a spreadsheet file, which shows the positional information of any interps made.

The System Info folder contains an APP.LOG file and a system summary diagnostic report. The APP.LOG file contains important information about system operation and may be requested by Sensors & Software to help troubleshoot any issues.

12.3 Field Interpretations File

If any interpretations are made a Field Interp Report file is created. This file is a CSV (Comma separated values) format, most commonly opened with Microsoft Excel.

The file will list any Interps and Flags added to data in the field. The position, depth and colour of each Interp is listed, along with GPS positions (if a GPS was connected). A sample output for this file is shown in Figure 12-4.

	A	B	C	D	E	F	G	H	I	J	K
1	Name	Count									
2	Pink	5									
3											
4	Tool	Interpretation	GPR Line	Position (m)	Depth (m)	Velocity	GPS-Easting (29S)	GPS-Northing (29S)	Latitude	Longitude	GPS-Elevation
5	Point	Pink	Lineset/line4	2.01	0.48	Wet Soil (0.08 m/ns)	484187.65	4298429.14	38.8345202	-9.1821844	16.63
6	Point	Pink	Lineset/line4	3.02	0.32	Wet Soil (0.08 m/ns)	484187.81	4298429.13	38.8345201	-9.1821826	16.6
7	Point	Pink	Lineset/line4	4.21	0.27	Wet Soil (0.08 m/ns)	484188.05	4298428.97	38.8345187	-9.1821798	16.59
8	Point	Pink	Lineset/line4	5.16	0.51	Wet Soil (0.08 m/ns)	484188.38	4298428.8	38.8345172	-9.1821759	16.56
9	Point	Pink	Lineset/line4	6.89	0.62	Wet Soil (0.08 m/ns)	484188.38	4298428.8	38.8345172	-9.1821759	16.56
10											

Figure 12-4: Contents of a sample Field Interp Report file

12.4 Google Earth™

Anytime a GPS is used, a .KMZ file is included as part of the exported data. If the internal GPS was used, you will only see screenshots and a layout of the grid (if a grid was collected). Clicking on the yellow camera icon in Google Earth™ will display the screenshot image ().

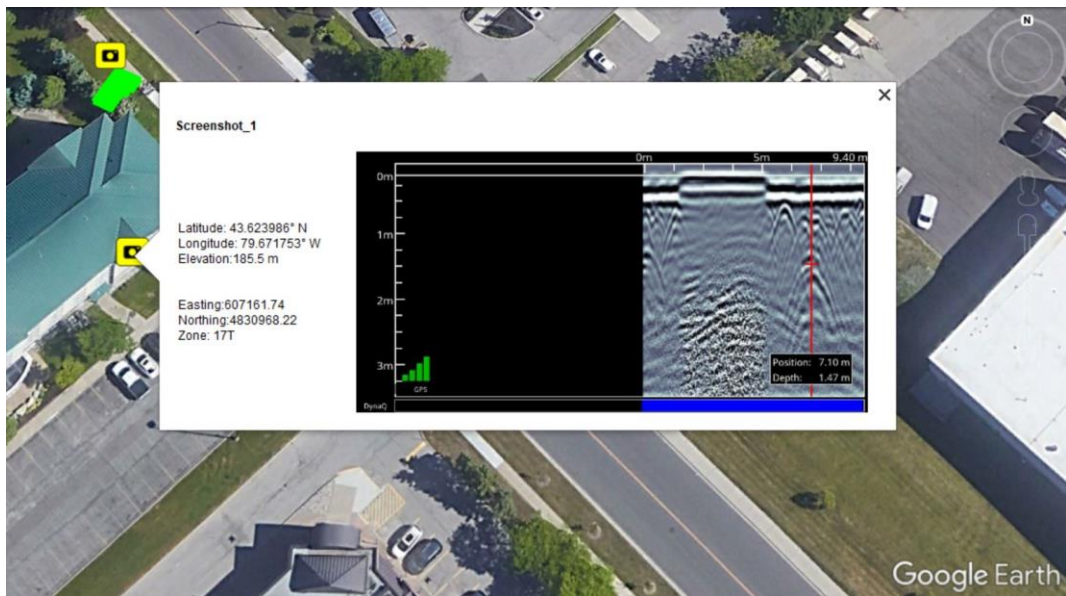

Figure 12-5: Google Earth™ image, showing a layout of the grid and some screenshots taken

Data collected with an external GPS will also show the path walked for any line scan data as well as any Interpretations and Flags (Figure 12-6).



Figure 12-6: Path travelled with Interpretations, collected using an External GPS

Opening the data in EKKO_Project™ and creating depth slices, will allow you to export those slices to Google Earth™ (Figure 12-7).



Figure 12-7: Depth slice displayed in Google Earth™

12.5 System Summary Report

The System Summary report is a PDF file, which lists system usage information, serial numbers and when system tests were done and their pass/fail status. An example file is shown below:

FINDAR

System Usage Summary August 04 2022

System Information

Display Unit (DVL) Serial Number	0094-6079-2004
GPR Sensor Serial Number	0058-9749-0004
Application Version	v1.1.658 (2018-00060-00)
OS Version	2.07.471 (2017-00041-07)
GPR Firmware Version	3.032 (2014-00092-04)
Hardware ID	5410EC6BFBEB

System Tests

Odometer Test	03 February 2022	Passed
GPS Test	03 August 2022	Failed
Keypad Test	03 February 2022	Passed
Audio Test	03 February 2022	Passed
Touch Screen Test	03 February 2022	Passed
GPR Sensor Test	03 February 2022	Passed

12.6 EKKO_Project™

Any line and grid data collected in a project are saved as a single .GPZ file (e.g. Project1.GPZ). This file can be opened with the EKKO_Project™ PC software.

EKKO_Project™ is powerful software that allows you to view, edit, process and ultimately create reports from your GPR data. Grid data that is processed in the field will immediately show up as depth slices in EKKO_Project™, as well as the path travelled in Map View.

From the main screen (Figure 12-8), you can access various views and launch modules that give you access to further functionality. Some features shown here are not part of the standard EKKO_Project™ base software. For more information, consult your EKKO_Project™ manual or contact Sensors & Software.

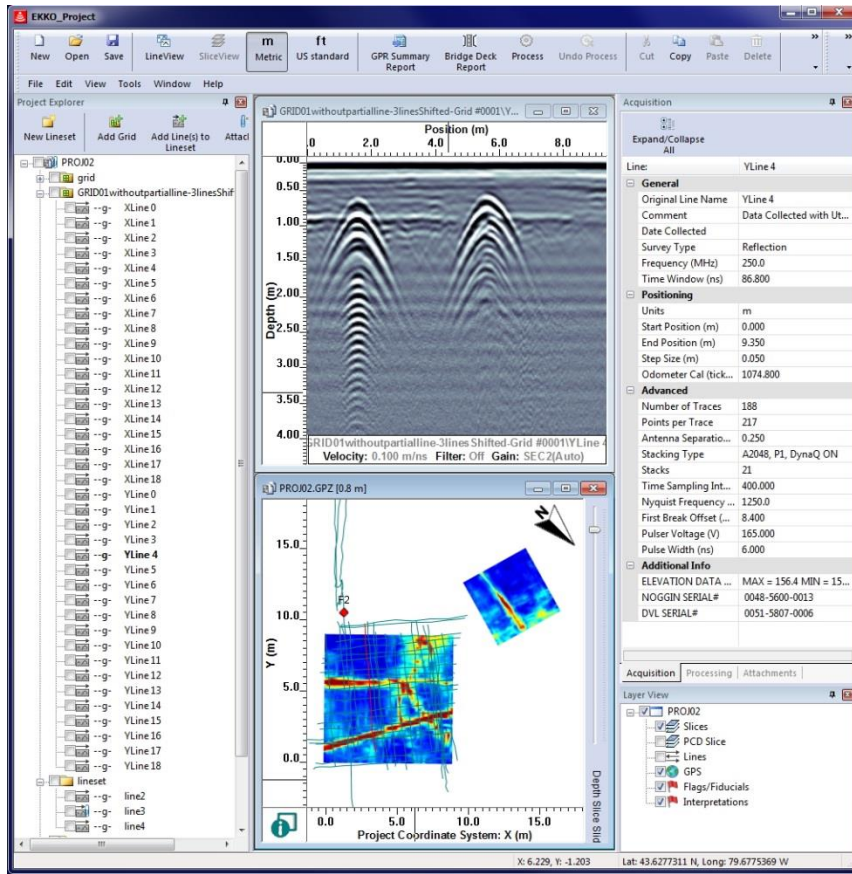

Figure 12-8: Main screen of EKKO_Project™

13 Troubleshooting

LMX150™ FINDAR® is designed to minimize user problems; however, all electronic devices are subject to possible failure. The following are troubleshooting hints which can be referred to if your system fails to operate.

13.1 System Does Not Power Up or Sensor Not Detected

If you have connected the cables to the LMX Sensor, Display Unit, and the battery, pressed the **Power** button on the Display Unit and:

- The Display Unit does not power up, or
- The LMX Sensor is not detected, and you get the following messages:

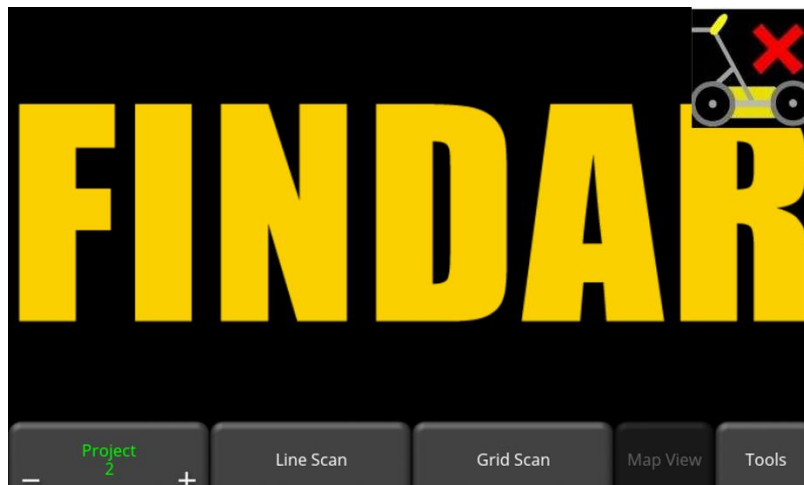
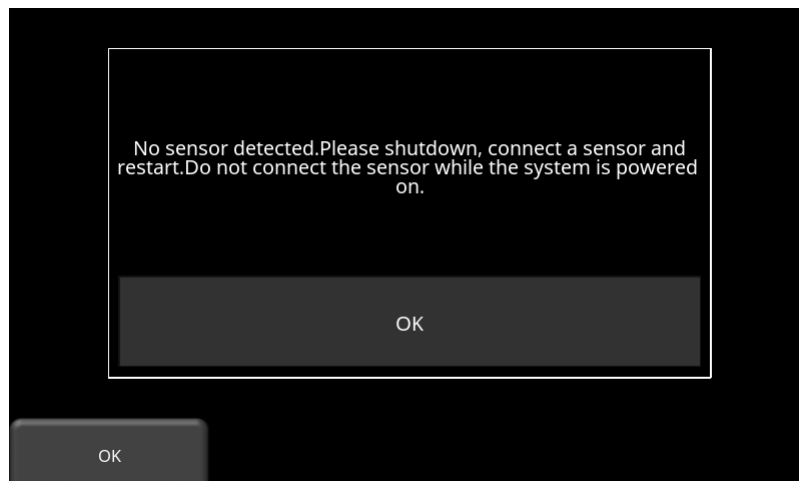

1) Wait at least 1-minute and see if the Display Unit starts up. Sometimes the Power LED on the Display Unit fails but the Display Unit is otherwise OK. If the application starts but the LED on the Display Unit does not turn on, test the operation of the LED using the **System Test > Keypad** test under **Tools** ([Section](#)).

2) Test the battery

- a) Check that the fuse, inside the battery case, has not blown. If so, replace the 10 Amp fuse with one of the spare fuses inside the battery case.
- b) Use a multimeter with fine tipped probes (1mm or 0.04 inches) to measure the battery voltage at the connector on the outside of the battery case. Measure the voltage between socket #1 (ground, using the black probe) and socket #4 (power, using the red probe). If the voltage is less than 10.5 volts, there is a problem with the battery.



3) Test the Battery Cable

Insert the battery cable into the battery and test the battery cable. Use a multimeter to measure the battery voltage at the connector at the end of the battery cable. Measure the voltage between socket #1 (ground, using the black probe) and socket #4 (power, using the red probe). If the voltage is less than 10.5 volts, there is a problem with the battery cable.



4) Check the LMX Sensor and Display Unit Connectors

Turn off the LMX system and disconnect the battery before disconnecting the cable that connects the Display Unit to the LMX Sensor.

a) On the back of the Display Unit, check that none of the 37 pins are missing, bent, or recessed. Look at the pins on an angle to confirm they are all flush with one another. If one is bent or recessed, gently bend the pin back straight and flush with the other pins. Then reconnect the cable and try powering the LMX system again.



b) Check all 37 sockets at the LMX connector, ensuring that none are blocked with debris. If so, clean out the debris, reconnect the cable and try powering the system again.



5) Replace the Cable

If you have a spare cable, replace the current cable. If the system does not power on or if the LMX Sensor is not detected with either cable, please contact your GPR supplier for further assistance.

6) Test the Cable

a) On the end of the cable that connects to the LMX Sensor, check that none of the 37 pins are missing, bent, or recessed. Look at the pins on an angle to confirm they are all flush with one another. If one is bent or recessed, gently bend the pin back straight and flush with the other pins. Connect the cable to the LMX Sensor and try powering the LMX system again.



b) Disconnect the end of the cable that connects to the back of the Display Unit.
c) Check all 37 sockets at the end of the cable, ensuring that none are blocked with debris. If so, clean out the debris, reconnect the cable and try powering the Display Unit again.



d) With the cable connected to the LMX Sensor and the battery connected to the system, check the power from the battery is reaching the Display Unit through the cable by using a multimeter to measure the voltage between socket #21 (ground, using the black probe)

and sockets #1 or #2 (power, using the red probe) on the end of the cable. If the voltage is zero, there may be a problem with the cable. If the voltage is at least 10.5 volts, the problem may be the Display Unit. Please contact your GPR supplier for further assistance.

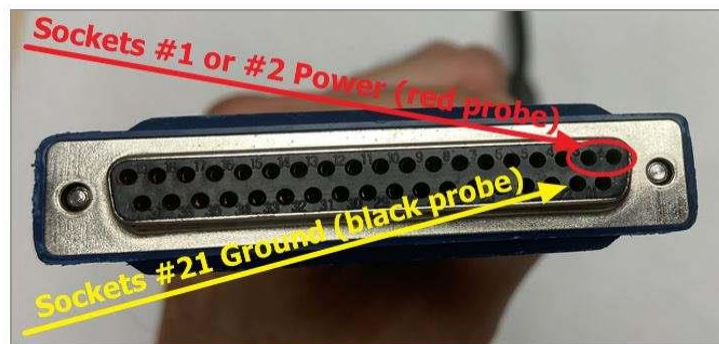

Display Unit Screen turns White After Powering Up

If the Display Unit screen turns completely white after powering up the system, the battery does not have enough voltage to completely power the system. Recharge or replace the battery

13.2 System Communications

If the battery is OK and the Display Unit turns on, but the GPR sensor does not scan, there may be a communication failure between the Display Unit and the GPR sensor. If an error occurs, an error message will appear. Power Off the system and disconnect the battery.

Make sure the display cable is not damaged, all pins are straight, and there is no dirt or debris in the connector. Ensure that the cable connections are tightly secured. Sometimes vibrations cause the cable connections to slightly loosen and break contact leading to errors.

Disconnecting the cable and reconnecting it may provide a better contact and solve the problem. Plug in the battery, turn on the system and try scanning again.

If the Battery, Battery Cable and Display Cable are OK, the problem is either a failure of the Display Unit or the GPR sensor. These units have no user-serviceable parts so they will have to be returned to the vendor for inspection and repair.

13.3 System Overheating

The GPR system is designed to operate to a maximum *internal* temperature of 70 C or 158 F. In situations of high ambient temperatures or long exposure to direct sun, this maximum internal temperature may be exceeded and cause the system to fail.

If you suspect that the GPR sensor is overheating, shut it off and give it a chance to cool down in a shady location before trying to run it again.

If the situation is such that the high temperatures or direct sun cannot be avoided, it may be a good idea to put some sort of shade over the GPR sensor.

13.4 Display Unit Problem

If the Display Unit does not power up, check the battery power and all cable connection. If that doesn't work, contact the manufacturer.

13.5 Wobbly Wheels

If, over time, a wheel becomes wobbly, the wheel nut will need to be manually tightened.

For the rear right wheel only (which is connected to the direct drive odometer), insert a large, slotted screwdriver into the end of the axle (there's already a slot there for it) and use a large wrench to slightly tighten the wheel nut. The nut only has to be turned slightly, 1/8th -1/16th of a turn is usually enough. Spin the wheel to make sure it's still free and not too tight.

13.6 Creating a Test Line for Data Quality

After receiving the system and getting comfortable with its operation, one of the best ways of detecting any problems is to collect a line of data at a convenient, easily accessible location. The line does not have to be too long, but one screen is a good guide. This data line should be saved electronically and perhaps plotted out on paper and dated. If there is a suspected problem with the system, this test line could be collected and compared with earlier tests. When comparing data, take into account weather and environmental conditions, which could skew the comparisons slightly.

13.7 Contacting the Vendor for Service

When returning the system to the Vendor, have the following information available:

- 1) GPR sensor Serial Number displayed at the top of the **System Settings Screen**.
- 2) A brief description of when the error is happening and the operating conditions (temperature, humidity, sunshine, system settings, etc.).
- 3) Include photos and/or videos to document the occurrence of error messages.
- 3) APP.LOG file – this is downloaded to your computer during data export

14 Care & Maintenance

14.1 Battery Care

LMX150™ FINDAR® uses a 9-Amp-hour, 12-Volt sealed lead acid battery. It is fused with a 10 Amp fuse to protect it from short circuit damage.

The battery unit should run the system continuously for 6 hours before recharging is necessary. If long days of data surveying are typical, a second battery unit may be useful.

The battery is strapped onto the cart base and is normally recharged without removing it from the cart. However, the battery can be easily removed for maintenance or for recharging, if required.

If batteries are maintained in a charged condition, they will give long life and reliable service. Improper use and lack of maintenance will greatly reduce their life.

Sealed lead acid batteries should **NEVER** be left in a discharged condition for any period of time. Charge the batteries as soon as possible after use.

Charge the battery at room temperature whenever possible.

LMX150™ FINDAR® has a voltage monitoring circuit that will turn off the unit when the input voltage drops below 10.8 volts.

If a battery has been deeply discharged or left in a discharged condition for some period of time it may not accept charge immediately when it is connected to the charger (the fast charge light will not illuminate). If the fast charge light does not come on within 6 hours the battery should be considered damaged and should be discarded.

Do not assume that a battery that is still charging after 8 hours is nearing the end of its charge cycle. Typical charging time for an empty battery is 12-14 hours from the start of fast charge.

Ensure that the batteries are fully charged before storing. If practical, store the batteries in a cool place, 10°C, but make sure the temperature is not likely to drop below -30°C or the electrolyte may freeze and possibly split the case.

14.2 Cable Care

With the use of this product in rough, dusty and outdoor environments, users can minimize potential downtime if they care for cables and treat connectors with respect.

- 1) The cable connectors as well as the connectors on the GPR Sensor and Display Unit need to stay clean and free of dust and moisture. Use a brush or air spray to clean dust, lint and other foreign particles from these connectors.
- 2) The power and odometer receptacles on the top of the LMX200™ are watertight, but do not allow water to get into the receptacle by connecting the battery and odometer cables in the rain
- 3) After working in rainy conditions, disconnect the cables and check for water in the receptacles. Remove the water or allow to air dry, if necessary. Never allow the system to sit in rainy conditions for long periods of time.
- 4) When the system is not being used, make sure the connections are protected to prevent dust and moisture from collecting inside. If the connectors are exposed, cover them with some sort of dust cap.

Cables and connectors are not designed to suspend or tow or otherwise carry the weight of systems. They are part of the electronic circuit and should be treated accordingly. When not in use they should be placed in their storage box.

14.3 Skid Pads

The bottom of the GPR Sensor is covered with one large wear-resistant skid pad. The skid pad is designed to take the majority of the abrasive wear. If the pad wears down enough, the less-resistant plastic housing may start to wear. If this occurs, it is best to replace the skid pad. It is easily removed with a screwdriver and a new one can be purchased from the vendor.

14.4 Odometer

The odometer should be periodically calibrated (refer to Section 4.4.6) to ensure accuracy.

14.5 Storage Cases

Equipment that is transported and stored loosely is more susceptible to damage. All equipment should be stored in its shipping case or a storage box. Sensors & Software has optional shipping cases available for all LMX150™ FINDAR® systems.

14.6 Upgrading Embedded Software on Display Unit

From time to time, Sensors & Software may release new software for the Display Unit. The instructions below describe how to update this software. Please note that this procedure will **erase all GPR data** from the system, so export any valuable data before continuing.

1 Download

the zip file provided by Sensors & Software into a folder on your PC.

2 Insert

a clean USB stick into your PC.

3 Unzip

the file by double clicking the file in Windows Explorer.

4 Copy

the unzipped folder to the root of the USB key. The resulting folder structure on the USB key should be:

```
dvl-apps
  app1
    PACKAGE_NAME.en
    PACKAGE_NAME.pkg
```

where PACKAGE_NAME is the name of the item to be installed. An example of the Conquest 100 installation files are shown below:

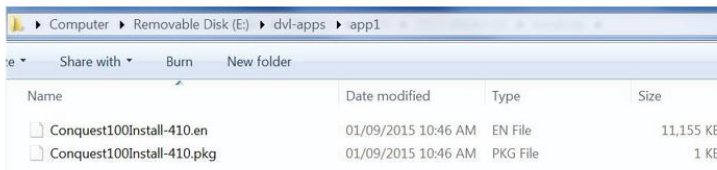

Name	Date modified	Type	Size
Conquest100Install-410.en	01/09/2015 10:46 AM	EN File	11,155 KB
Conquest100Install-410.pkg	01/09/2015 10:46 AM	PKG File	1 KB

5 Turn off

the Display Unit. Remove the USB stick from your PC and insert it into the USB port on the side of the Display Unit.

**6 Turn On**

the Display Unit. You will see a list on the screen showing all software installations. The USB key may hold one or more packages which are displayed as numbered items:

```
Select app to run:
1. PACKAGE_NAME
```

7 Select

the package to run by pressing the associated numbered key on the Display Unit. The selected software will now be installed. The process may require multiple reboot cycles initiated by the system. When complete, the system will shut down, and the red light on the front of the Display Unit will turn off.

8 Remove

the USB stick from the Display Unit.

9 Turn On

the Display Unit and access the System Info screen to verify the newly installed version number.

15 Parts List & Accessories

15.1 Spare Parts

The following is a list of spare parts available for purchase, with labelled diagram below that:

122-10-2377	Cart Wheel
100-55-0023	Battery with Case
100-53-0098	Display Unit Tray
100-52-0108	Display Cable
126-77-1450	Skid Plate
126-77-2010	Battery Cable
100-55-0027	Battery Charger
100-22-0084	GPR Sensor
100-22-0085	Display Unit
126-85-0670	Cart Handle
126-81-1600	Cart Base
100-54-0154	<p>LMX Spare Parts Kit consisting of:</p> <ul style="list-style-type: none"> • Safety Locking Pins (1) • Display Unit Tray Knob & Screw (1) • Sensor Support Straps (4) • Standoff hex (2) • Sensor to Display Unit cable jack screws (2)

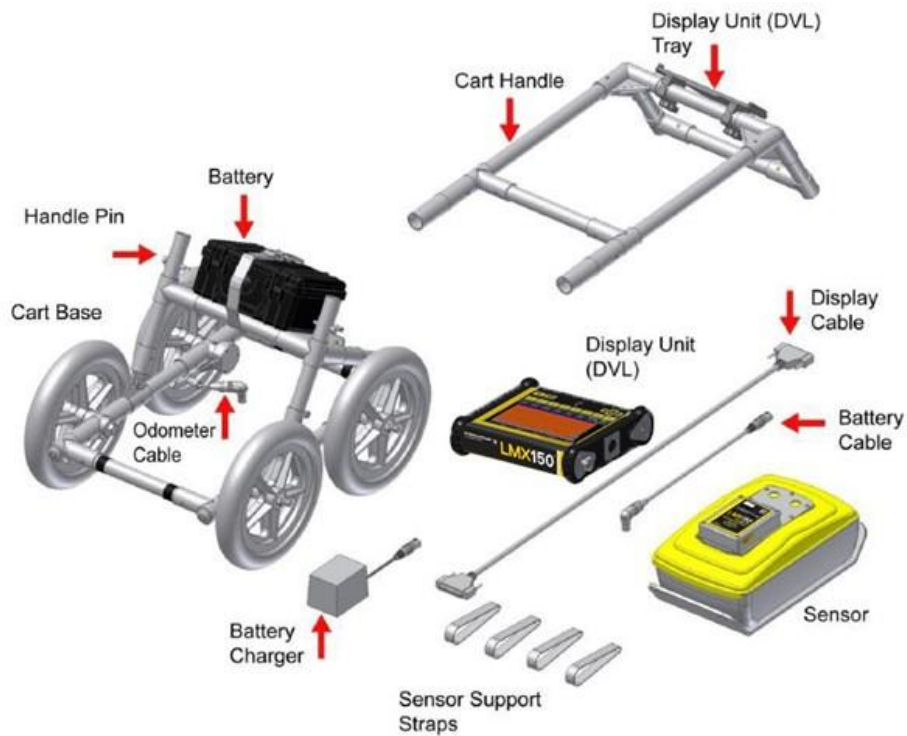

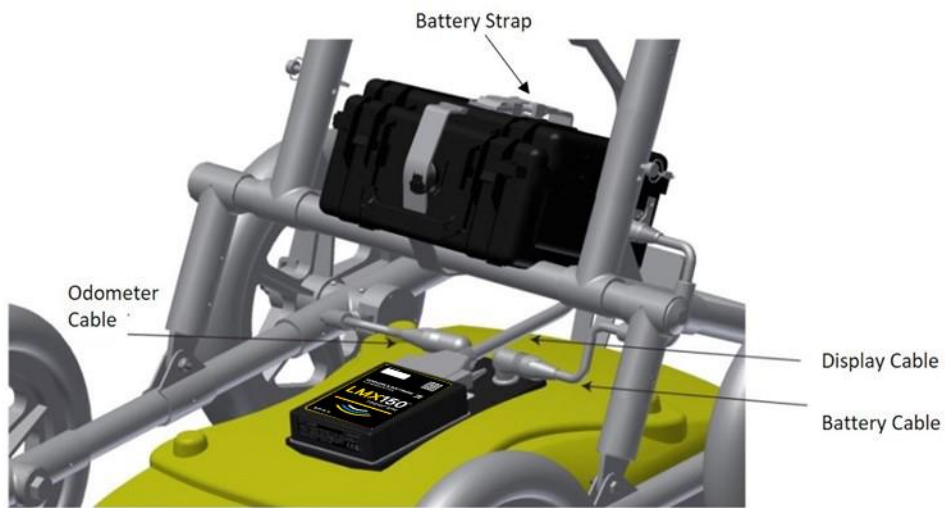

15.2 Accessories

The following accessories are available for purchase:



100-60-0061 Series ATA Shipping Case (with DVL Bag)



100-55-0023 Spare Battery



100-55-0027 Spare Battery Charger



100-60-0066 Deluxe Display Unit Carrying Case



100-54-0150 AG-200 GPS Kit

EKKO_Project GPR Analysis Software

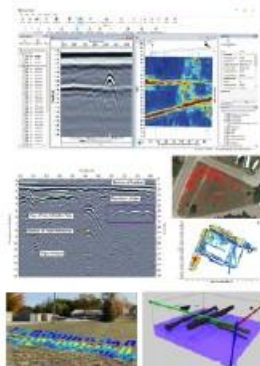

- 100-11-0121** Core Bundle
- 100-11-0122** Examine Bundle
- 100-11-0123** Reveal Bundle
- 100-11-0124** Suite Bundle
- 100-11-0125** 3D Reveal Bundle
- 100-11-0126** 3D Suite Bundle

16 Technical Specifications

Specifications	Values
GPR Sensor size	380 x 230 x 150 mm (15 x 9 x 6 in)
GPR Sensor weight	3 kg (6.5 lbs)
Display Unit weight	2.83 kg (6.24 lbs)
Display Unit screen	8.0" high-visibility, sunlight-readable diagonal LCD display with touch screen Adjustable backlighting 1500 NIT and 800:1 contrast ratio
Battery weight	3.6 kg (7.9 lbs)
Total system weight	19 kg (41 lbs)
Wireless	Integrated modules: Wi-Fi (IEEE 802.11 b,g,n) GPS/GLONASS
Audio	Built-in speaker - 85dBA speaker w/volume control
Battery	Lead acid gel cell Battery Life: 4-6 hours Battery Capacity:9.0 Ah
Charger	Built-in charger with status indicator Universal AC mains charger input: 100-240V \sim , 1.5A, 50/60Hz Output: 12 Volts @ 3 Amps
Display Unit Input	11-18V $\overline{\text{---}}$, 4A maximum
Display Unit Power Consumption*	1.5A @ 12V
Temperature & Environmental 	Ruggedized, environmentally sealed unit and connections. Ingress protection (IP) rating: Display Unit is rated to IP65 under IEC 60529 Relative Humidity operation (non-condensing): 10 – 90% GPR Sensor operating temperature range: -40 to 50°C Display Unit operating temperature range: -30 to 50°C Do not use touch screen below -20°C. Use battery charger between 0 and 30°C.
Regulatory Specifications	EMC-FCC, CE, IC, ACA, RSM Safety-TUV, CE

** The power specification represents average power consumption. Power profile varies at initial power-up, and under different operating conditions. Sensors & Software supplied batteries can handle the variation in power profile. Care should be taken if powering systems with another power source.*

Appendix A: Health & Safety Certification

Radio frequency electromagnetic fields may pose a health hazard when the fields are intense. Normal fields have been studied extensively over the past 30 years with no conclusive epidemiology relating electromagnetic fields to health problems. Detailed discussions on the subject are contained in the references and the web sites listed below.

The USA Federal Communication Commission (FCC) and Occupational Safety and Health Administration (OSHA) both specify acceptable levels for electromagnetic fields. Similar power levels are mandated by corresponding agencies in other countries. Maximum permissible exposures and time duration specified by the FCC and OSHA vary with excitation frequency. The lowest threshold plane wave equivalent power cited is 0.2 mW/cm² for the general population over the 30 to 300 MHz frequency band. All other applications and frequencies have higher tolerances as shown in graphically in Figure B-1.

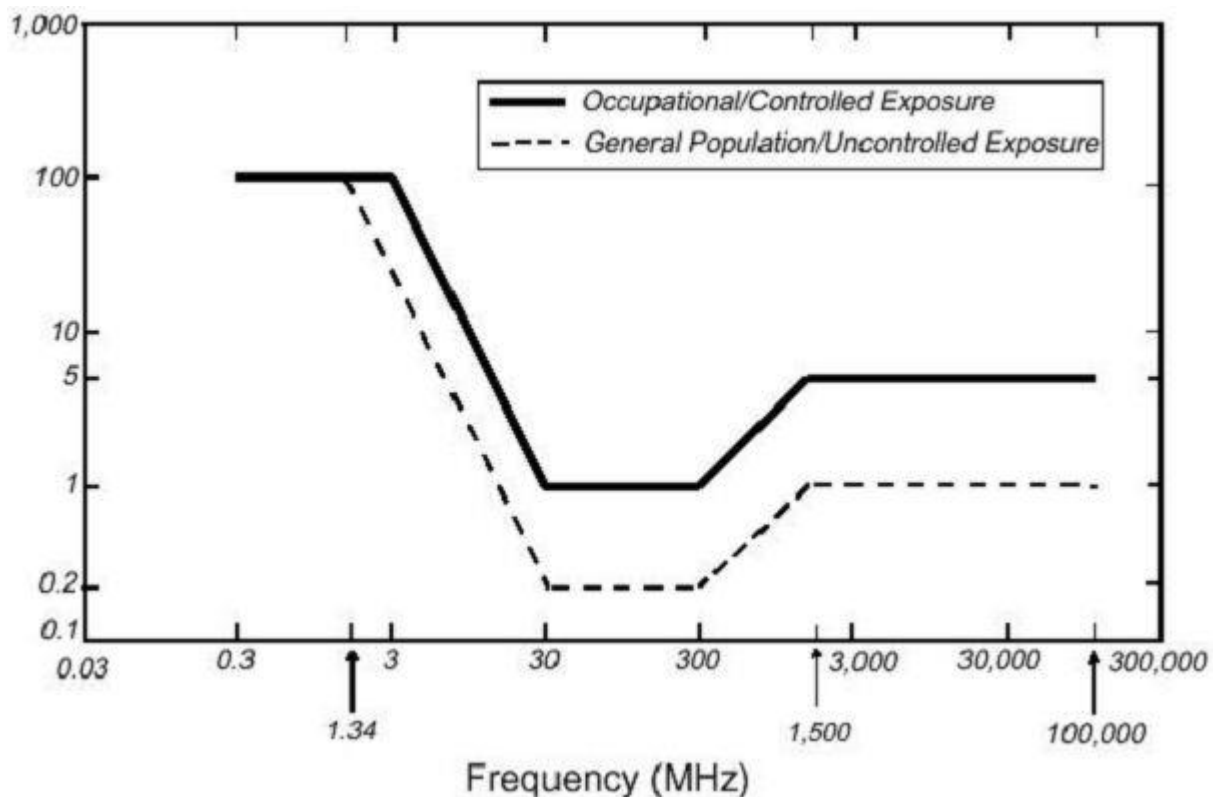

Figure B-16-1: FCC limits for maximum permissible exposure (MPE) plane-wave equivalent power density mW/cm².

All Sensors & Software Inc. GPR products are normally operated at least 1 m from the user and as such are classified as “mobile” devices according to the FCC. Typical power density levels at a distance of 1 m or greater from any Sensors & Software Inc. products are less than 10⁻³ mW/cm² which is 200 to 10,000 times lower than mandated limits. As such, Sensors & Software Inc. products pose no health and safety risk when operated in the normal manner of intended use.

Appendix B: GPR Emissions, Interference and Regulations

All governments have regulations on the level of electromagnetic emissions that an electronic apparatus can emit. The objective is to assure that one apparatus or device does not interfere with any other apparatus or device in such a way as to make the other apparatus non-functional.

The manufacturer test their GPR products using independent professional testing houses and comply with latest regulations of the USA, Canada, European Community, and other major jurisdictions on the matter of emissions.

Electronic devices have not always been designed for proper immunity. If a GPR instrument is placed in close proximity to an electronic device, interference may occur. While there have been no substantiated reports of interference to date, if any unusual behavior is observed on nearby devices, test if the disturbance starts and stops when the GPR instrument is turned on and off. If interference is confirmed, stop using the GPR.

Where specific jurisdictions have specific GPR guidelines, these are described below.

B-1 FCC Regulations

This device complies with Part 15 of the USA Federal Communications Commission (FCC) Rules. Operation in the USA is subject to the following two conditions:
this device may not cause harmful interference and

this device must accept any interference received, including interference that may cause undesired operation.

Part 15 – User Information

This equipment has been tested and found to comply with the limits for a Class A digital device, where applicable, and for an ultra-wide bandwidth (UWB) device where applicable, pursuant to Part 15 of the FCC Rules. These limits are designed to provide reasonable protection against harmful interference when the equipment is operated in a commercial environment. This equipment uses and can radiate radio frequency energy and, if not installed and used in accordance with the instruction manual, may cause harmful interference to radio communications. Operation of this equipment in a residential area is likely to cause harmful interference in which case the user will be required to correct the interference at his/her own expense.

WARNING

Changes or Modifications not expressly approved by the manufacturer could void the user's authority to operate the equipment.

Certification of this equipment has been carried out using approved cables and peripheral devices. The use of non-approved or modified cables and peripheral devices constitutes a Change or Modification outlined in the warning above.

Operating Restrictions

Operation of this device is limited to purposes associated with law enforcement, firefighting, emergency rescue, scientific research, commercial mining, or construction. Parties operating this equipment must be eligible for licensing under the provisions of Part 90 of this chapter.

FCC Interpretation of Operation Restrictions issued July 12, 2002

(FCC Order DA02-1658, paragraph 9)

The regulations contain restrictions on the parties that are eligible to operate imaging systems (See 47 C.F.R. 5.509(b), 15.511(b), and 15.513(b)). Under the new regulations, GPRs and wall imaging systems may be used only by law enforcement, fire and emergency rescue organizations, by scientific research institutes, by commercial mining companies, and by construction companies. Since the adoption of the *Order*, we have received several inquiries from the operators of GPRs and wall imaging systems noting that these devices often are not operated by the users listed in the regulations but are operated under contract by personnel specifically trained in the operation of these devices. We do not believe that the recent adoption of the UWB rules should disrupt the critical safety services that can be performed effectively only through the use of GPRs and wall imaging systems. We viewed these operating restrictions in the broadest of terms. For example, we believe that the limitation on the use of GPRs and wall imaging systems by construction companies encompasses the inspection of buildings, roadways, bridges and runways even if the inspection finds no damage to the structure and construction does not actually result from the inspection; the intended purpose of the operation of the UWB device is to determine if construction is required. We also believe that the GPRs and wall imaging systems may be operated for one of the purposes described in the regulations but need not be operated directly by one of the described parties. For example, a GPR may be operated by a private company investigating forensic evidence for a local police department.

FCC Permitted Mode of Usage

The GPR antenna must be kept on the surface to be in compliance with FCC regulations. Use of the antenna is not permitted if it is lifted off the surface. Use as a through-the-wall imaging device is prohibited.

GPR Use Coordination

FCC regulation 15.525(c) (updated in February 2007) requires users of GPR equipment to coordinate the use of their GPR equipment as described below:

TITLE 47--TELECOMMUNICATION

CHAPTER I--FEDERAL COMMUNICATIONS COMMISSION

PART 15_RADIO FREQUENCY DEVICES

Subpart F_Ultra-Wideband Operation Sec.

15.525 Coordination requirements.

(a) UWB imaging systems require coordination through the FCC before the equipment may be used. The operator shall comply with any constraints on equipment usage resulting from this coordination.

(b) The users of UWB imaging devices shall supply operational areas to the FCC Office of Engineering and Technology, which shall coordinate this information with the Federal Government through the National Telecommunications and Information Administration. The information provided by the UWB operator shall include the name, address and other pertinent contact information of the user, the desired geographical area(s) of operation, and the FCC ID number and other nomenclature of the UWB device. If the imaging device is intended to be used for mobile applications, the geographical area(s) of operation may be the state(s) or county(ies) in which the equipment will be operated. The operator of an imaging system used for fixed operation shall supply a specific geographical location or the address at which the equipment will be operated. This material shall be submitted to:

Frequency Coordination Branch, OET

Federal Communications Commission
445 12th Street, SW, Washington, D.C.
20554

Attn: UWB Coordination

(Sensors & Software Inc. Note: The form given on the following page is a suggested format for performing the coordination.)

(c) The manufacturers, or their authorized sales agents, must inform purchasers and users of their systems of the requirement to undertake detailed coordination of operational areas with the FCC prior to the equipment being operated.

(d) Users of authorized, coordinated UWB systems may transfer them to other qualified users and to different locations upon coordination of change of ownership or location to the FCC and coordination with existing authorized operations.

(e) The FCC/NTIA coordination report shall identify those geographical areas within which the operation of an imaging system requires additional coordination or within which the operation of an imaging system is prohibited. If additional coordination is required for operation within specific geographical areas, a local coordination contact will be provided. Except for operation within these designated areas, once the information requested on the UWB imaging system is submitted to the FCC no additional coordination with the FCC is required provided the reported areas of operation do not change. If the area of operation changes, updated information shall be submitted to the FCC following the procedure in paragraph (b) of this section.

(f) The coordination of routine UWB operations shall not take longer than 15 business days from the receipt of the coordination request by NTIA. Special temporary operations may be handled with an expedited turn-around time when circumstances warrant. The operation of UWB systems in emergency situations involving the safety of life or property may occur without coordination provided a notification procedure, similar to that contained in Sec. 2.405(a) through (e) of this chapter, is followed by the UWB equipment user.[67 FR 34856, May 16, 2002, as amended at 68 FR 19751, Apr. 22, 2003]

Effective Date Note: At 68 FR 19751, Apr. 22, 2003, Sec. 15.525 was amended by revising [[Page 925]] paragraphs (b) and (e). This amendment contains information collection and recordkeeping requirements and will not become effective until approval has been given by the Office of Management and Budget.

FCC GROUND PENETRATING RADAR COORDINATION NOTICE

NAME:

ADDRESS:

CONTACT INFORMATION [CONTACT NAME AND PHONE NUMBER]:

AREA OF OPERATION [COUNTIES, STATES OR LARGER AREAS]:

FCC ID: QJQ-NG500

EQUIPMENT NOMENCLATURE: NG500

Send the information to:

Frequency Coordination Branch., OET

Federal Communications Commission

445 12th Street, SW

Washington, D.C. 20554

ATTN: UWB Coordination

Fax: 202-418-1944

INFORMATION PROVIDED IS DEEMED CONFIDENTIAL

B-2 ETSI Regulations for the EC (European Community)

In the European Community (EC), GPR instruments must conform to ETSI (European Technical Standards Institute) standard EN 302 066-1 v1.2.1. Details on individual country requirements for licensing are coordinated with this standard. For more information, contact Sensors & Software's technical staff.

All Sensors & Software ground penetrating radar (GPR) products offered for sale in European Community countries or countries adhering to ETSI standards are tested to comply with EN 302 066 v1.2.1.

For those who wish to get more detailed information, they should acquire copies of the following documents available from ETSI.

ETSI EN 302 066-1 V1.2.1 (February 2008) Electromagnetic compatibility and Radio spectrum Matters (ERM); Ground and Wall- Probing Radar applications (GPR/WPR) imaging systems; Part 1: Technical characteristics and test methods

ETSI EN 302 066-2 V1.2.1 (February 2008) Electromagnetic compatibility and Radio spectrum Matters (ERM); Ground and Wall- Probing Radar applications (GPR/WPR) imaging systems; Part 2: Harmonized EN covering essential requirements of article 3.2 of the R&TTE Directive

ETSI TR 101 994-2 V1.1.2 (March 2008) Electromagnetic compatibility and Radio spectrum Matters (ERM); Short Range Devices (SRD); Technical characteristics for SRD equipment using Ultra Wide Band technology (UWB); Part 2: Ground- and Wall- Probing Radar applications; System Reference Document

B-3a Industry Canada Regulations - English

Industry Canada published its regulations for ground penetrating radar (GPR) on Mar 29 2009 as part of the RSS-220 titled 'Devices Using Ultra-Wideband (UWB) Technology'.

Industry Canada has made a unique exception for GPR by not requiring user licensing. The user does have to comply with the following directives:

This Ground Penetrating Radar Device shall be operated only when in contact with or within 1 m of the ground.

This Ground Penetrating Radar Device shall be operated only by law enforcement agencies, scientific research institutes, commercial mining companies, construction companies, and emergency rescue or firefighting organizations.

Should the ground penetrating radar be used in a wall-penetrating mode then the following restriction should be noted by the user:

This In-wall Radar Imaging Device shall be operated where the device is directed at the wall and in contact with or within 20 cm of the wall surface.

This In-wall Radar Imaging Device shall be operated only by law enforcement agencies, scientific research institutes, commercial mining companies, construction companies, and emergency rescue or firefighting organizations.

Since operation of GPR is on a license-exempt basis, the user must accept the following:

Operation is subject to the following two conditions: (1) this device may not cause interference, and (2) this device must accept any interference, including interference that may cause undesired operation of the device.

B-3b Règlement d'Industrie Canada - Français

Industrie Canada a publié des règlements pour les appareils géoradar (GPR) le 29 mars 2009, dans le cadre du RSS-220 intitulé "Dispositifs utilisant la bande ultra-large (UWB)".

Industrie Canada a faite une exception unique pour GPR en n'exigeant pas de licence par utilisateur. L'utilisateur doit se conformer aux directives suivantes:

Ce géoradar périphérique doit être utilisé que lorsqu'il est en contact avec ou moins de 1 m du sol.

Ce géoradar périphérique doit être utilisé que par les organisations d'application de la loi, les instituts de recherche scientifique, des sociétés minières commerciales, entreprises de construction et de secours d'urgence ou des organisations de lutte contre les incendies.

Si le géoradar est utilisé dans un mode de pénétration au mur, la restriction suivante est à noter par l'utilisateur:

Ce dispositif d'imagerie radar doit être utilisé lorsque l'appareil est orienté vers le mur et en contact avec ou dans les 20 cm de la surface du mur.

Ce dispositif d'imagerie radar doit être utilisé que par les organisations d'application de la loi, les instituts de recherche scientifique, des sociétés minières commerciales, entreprises de construction et de secours d'urgence ou des organisations de lutte contre les incendies.

Parce que l'exploitation de GPR est sur une base exempte de licence, l'utilisateur doit accepter le texte suivant:

La fonctionnement est soumis aux deux conditions suivantes: (1) cet appareil ne peut pas provoquer d'interférences et (2) cet appareil doit accepter toute interférence, y compris les interférences qui peuvent causer un mauvais fonctionnement du dispositif

Appendix C: Instrument Interference

Immunity regulations place the onus on instrument/apparatus/device manufacturers to assure that extraneous interference will not unduly cause an instrument/apparatus/device to stop functioning or to function in a faulty manner.

Based on independent testing house measurements, Sensors & Software Inc. systems comply with such regulations in Canada, USA, European Community and most other jurisdictions. GPR devices can sense electromagnetic fields. External sources of electromagnetic fields such as TV stations, radio stations and cell phones, can cause signals detectable by a GPR which may degrade the quality of the data that a GPR device records and displays.

Such interference is unavoidable but sensible survey practice and operation by an experienced GPR practitioner can minimize such problems. In some geographic areas emissions from external sources may be so large as to preclude useful measurements. Such conditions are readily recognized and accepted by the professional geophysical community as a fundamental limitation of geophysical survey practice. Such interference being present in the GPR recordings is not considered as an equipment fault or as a failure to comply with immunity regulations.

Appendix D: Safety around Explosive Devices

Concerns are expressed from time to time on the hazard of GPR products being used near blasting caps and unexploded ordnance (UXO). Experience with blasting caps indicates that the power of Sensors & Software Inc.'s GPR products is not sufficient to trigger blasting caps. Based on a conservative independent testing house analysis, we recommend keeping the GPR transmitters at least 5 feet (2m) from blasting cap leads as a precaution. Some customers do experimental trials with their particular blasting devices to confirm with safety. We strongly recommend that GPR users routinely working with explosive devices develop a systematic safety methodology in their work areas.

The UXO issue is more complex and standards on fuses do not exist for obvious reasons. To date, no problems have been reported with any geophysical instrument used for UXO. Since proximity and vibration are also critical for UXO, the best advice is to be cautious and understand the risks.

Appendix E: Wi-Fi Module

FCC Notice:

NOTE: This equipment has been tested and found to comply with the limits for a Class A digital device, pursuant to part 15 of the FCC Rules. These limits are designed to provide reasonable protection against harmful interference when the equipment is operated in a commercial environment. This equipment generates, uses, and can radiate radio frequency energy and, if not installed and used in accordance with the instruction manual, may cause harmful interference to radio communications. Operation of this equipment in a residential area is likely to cause harmful interference in which case the user will be required to correct the interference at his/her own expense.

Industry Canada Notice:

This device complies with Industry Canada's license-exempt RSSs. Operation is subject to the following two conditions:

- (1) This device may not cause interference; and
- (2) This device must accept any interference, including interference that may cause undesired operation of the device.

Appendix F: Calibration

This Ground Penetrating Radar (GPR) system has been manufactured according to Sensors & Software's strict quality standards. All components used in the manufacture of this product are obtained from qualified vendors.

This product has been through a stringent set of tests to ensure all quality requirements are met which includes final system calibration and configuration.

This system is equipped with built-in diagnostic tests. By running the tests and getting a passing result, you can be confident that the system is operating within specification. No further user calibration is required.

Our Mission

Provide best in class equipment and solutions, to prevent damage to critical infrastructure, manage assets and protect lives.

Our Vision

To be the world's leader in the management of critical infrastructure and utilities.

Our locations



USA

Raymond, ME
Kearneysville, WV

Canada

Vaughan, ON
Mississauga, ON



Europe

United Kingdom **HQ**
France
Germany
The Netherlands



Asia Pacific

India
China
Hong Kong
Indonesia
Australia

Visit: www.sensoft.ca Follow us on:



Copyright © 2022 Radiodetection Ltd. All Rights Reserved. Sensors & Software is a registered trademark of Radiodetection in the United States and/or other countries. Trademarks and Notices. The following are trademarks of Radiodetection : LMX®, LMX150™ FINDAR®, EKKO_Project™ and DynaQ®. Due to a policy of continued development, we reserve the right to alter or amend any published specification without notice. This document may not be copied, reproduced, transmitted, modified or used, in whole or in part, without the prior written consent of Radiodetection Ltd.

2018-00042-02